



California Outdoor LLC

Simple. Intuitive. Furnishings.



LIFE'S INTERMISSION



*Site furnishings
& Park amenities*

7 REASONS TO CHOOSE THE SUPERIOR
PERFORMANCE OF **LIONCOAT**

LIONCOAT is a premium thermoplastic coating with superior adhesion that creates a seal tight bond to the metal surface and ensures a smooth, shiny finish without the use of PVC.

SUPERIOR
ADHESION



RESISTANCE TO
CUTTING AND
VANDALISM



ENVIRONMENTALLY
FRIENDLY



NO RUNS
OR DRIPS



UV PROTECTION



EASILY
REPAIRED



SMOOTH
FINISH
PREVENTS
MOLD AND
MILDEW





02

PREMIUM COLLECTION

Features sleek designs to enhance any landscape.

Alexandria	3	Carmel	11
Sydney	4	Monterey	12
Sienna	5	Florence	13
St. Peter	6	Mason Lee	14
LaMarche	7	Campus Commons	15
Madison	8	5th Avenue	16
Sahara	9	Augustus	17
Brooklyn	10		

70

ACCESSORIES

Add matching accessories to complete your space.

Receptacles & Planters	71
Umbrellas	72-73
Bollards	74-75
Bike Racks	76-78
Grills	79-80
Recreation	81

18

LIONCOAT COLLECTION

Features premium thermoplastic coating for lasting durability.

Benches	18-27
Tables	28-41
Receptacles/Planters	42-49
Customization	50-51
Early Childhood	52-55

82

SHOWCASE

Transform your outdoor space into a community destination.

DogPark	83-85
ActionFit	86-87
UltraShade/UltraShelter	88
Bicycle Parking	89
Grandstands	90

56

NATURAL COLLECTION

Features 100% recycled plastic, wood & aluminum for a more natural look.

Recycled Benches	56-59
Recycled Tables	60-64
Recycled Planters/Receptacles	65-66
100% Recycled	67
Aluminum	68
Recycled Early Childhood	69

92

SPECIFICATIONS

Warranties	93
Plank & Color Options	94
	95-97

PREMIUM COLLECTION



ALEXANDRIA
COLLECTION



02B-974-S6 6' Alexandria Bench, vertical slats, ultra silver metallic

02B-974 | ALEXANDRIA BENCH

The Alexandria Bench features high arching arms and your choice of vertical or horizontal slats.

- 4', 6', and 8' lengths
- Cast aluminum frame with powder coated finish
- Bolt together design
- All MIG Welded
- All stainless steel hardware
- Available in vertical or horizontal slats
- Portable (P) and/or surface mount (SM)
- Optional Center Arm Kit (P-974-ARM) available and sold separately
- See page 97 for color options



02B-974-HS6 6' Alexandria Bench, horizontal slats, matte black

	4 FOOT	6 FOOT	8 FOOT
Vertical Slats	02B-974-S4	02B-974-S6	02B-974-S8-
Horizontal Slats	02B-974-HS4	02B-974-HS6	02B-974-HS8



01R-CL-36 Franklin Door Receptacle, vertical slat, black with matching fl at top lid

01R-CL-36 | FRANKLIN DOOR RECEPTACLE

- 1/4" x 1-1/2" steel flat bar
- All MIG welded frame
- Only available in powder coated finish
- All stainless steel hardware
- Portable and/or surface mount
- Lid and liner included

FLAT TOP LID	ASH URN LID	RAIN BONNET LID
01R-CL-36FT	01R-CL-36AU	01R-CL-36RB

SYDNEY
COLLECTION

10-RDHS Hartford Table, Blue Vein



02B-11SM-HS4 4' Sydney Bench, Black

02B-11/12 | SYDNEY BENCH

- 4' and 6' lengths
- Powder coated finish
- Available with (11) or without back (12)
- Inground (S) or surface mount (SM)
- See page 97 for color options

	4 FOOT	6 FOOT
11 SERIES	02B -11-HS4	02B -11-HS6
12 SERIES	02B -12-HS4	02B -12-HS6



10-RDHS Sydney Table, Black

10 - R D H S SYDNEY TABLE

- 36" solid table top with umbrella hole
- Powder coated finish
- Portable and/or surface mount
- See page 97 for color options



922-S6-02B Sienna Bench, Slat, Green



02B-922-S6 6' Sienna Bench, slat, black



B BOW



M MORNING



S SLAT

02B-9 2 2 | SIENNA BENCH

- 4', 6', and 8' lengths
- Standard in thermoplastic
- Powder coat available for an upcharge
- 2" x 2" all MIG welded square tube frame
- All stainless steel hardware
- Portable and/or surface mount
- See page 97 for color options

4 FOOT	6 FOOT	8 FOOT
02B-922-B4	02B-922-B6	02B-922-B8
02B-922-M4	02B-922-M6	02B-922-M8
02B-922-S4	02B-922-S6	02B-922-S8



01R-SV-S32FT Trash Receptacle, slat, black

01R-S V-3 2 | TRASH RECEPTACLE

- 32 gallon capacity
- 29" square x 33-1/2" high
- Standard in thermoplastic
- Powder coat available for an upcharge
- Lid and plastic liner included
- 2" x 2" all MIG welded square tube frame
- Portable and/or surface mount
- See page 97 for color options

FLAT TOP LID	ASH URN LID	RAIN BONNET LID
01R-SV-B32FT	01R-SV-B32AU	01R-SV-B32RB
01R-SV-M32FT	01R-SV-M32AU	01R-SV-M32RB
01R-SV-S32FT	01R-SV-S32AU	01R-SV-S32RB



91C-S6-02B St. Peter Bench, vertical slat, bronze

02B-91/92 | ST. PETER BENCH

- 2', 4', 6', or 8' lengths
- Fully welded bench with powder coated finish
- Vertical or Horizontal Slats
- Frame is a 1" x 1" square solid steel bar
- Ships assembled for quick installation
- Available with (91) and without back (92)
- Portable and/or surface mount
- Optional Center Arm (C) and No Side Arms (N)
- See page 97 for color options



02B-92-S6 6' St. Peter Bench without Back, vertical slat, black

	2 FOOT	4 FOOT	6 FOOT	8 FOOT
91 SERIES				
Vertical Slats	02B-91-S2	02B-91-S4	02B-91-S6	02B-91-S8
Horizontal Slats	02B-91-HS2	02B-91-HS4	02B-91-HS6	02B-91-HS8
92 SERIES				
Vertical Slats	02B-92-S4	02B-92-S6		
Horizontal Slats	02B-92-HS4	02B-92-HS6		



364-RDSD St. Peter Table, solid table top with 91-S2-02B 2' St. Peter Bench, vertical slat, brown finish



30-SM St. Peter Table with 4 seats, vertical slat, black

364/30 ST. PETER TABLE

- The 30 round table comes complete with 2, 3, or 4 freestanding seats, powder coated finish, and inground or surface mount
- The portable 364 table has a round solid top with a powder coated finish (chairs not included)
- Inground or surface mount (30) and portable (364)
- See page 97 for color options

364 SERIES	ROUND	30 SERIES	4 SEATS	3 SEATS (Single Access)	2 SEATS (Double Access)
	364-RDSD		30-S	30H-S	30H2-S



93N-HS6-02B 6' LaMarche Bench with Back, no arm rests, spartan bronze



02B-94N-HS6 6' LaMarche Bench with Back, no arm rests, spartan bronze

02B-93 / 94 LAMARCHE BENCH

- 6' length
- Powder coated finish
- All MIG welded
- Legs are made from 3/4" laser cut steel plate
- Fully welded
- Available with (93) and without back (94)
- Portable and/or surface mount
- Optional Center Arm (C), and No Side Arms (N)
- See page 97 for color options

93 SERIES	6 FOOT
No Arms	02B-93N-HS6
Side & Center Arms	02B-93C-HS6
Side Arms	02B-93-HS

94 SERIES	6 FOOT
No Arms	02B-94N-HS6
Side Arms	02B-94-HS6

01R-AG-36 | LAMARCHE RECEPTACLE

- 36 gallon capacity
- Only available in powder coated finish
- 1-1/2" x 1/4" flat steel strips
- Top and bottom rings are 1" pipe
- All MIG welded frame
- Portable and/or surface mount
- Lid and liner included
- See page 97 for color options



01R-AG-36FT LaMarche Receptacle, vertical slat, fl at top lid, spartan bronze

FLAT TOP	ASH URN	RAIN BONNET
01R-AG-36FT	01R-AG-36AU	01R-AG-36RB



MADISON
COLLECTION

50SM-HX Huntington Table with 4 Chairs, blue vein



02B-53-HX6 6' Madison Bench with Back, spartan bronze

02B-5 2 / 5 3 MADISON BENCH

- 2', 4', 6' and 8' lengths available
- 1-1/2" square tubing
- Features hexagonal geometric shapes and straight lines for a modern look
- Available with (53) or without back (52)
- Portable and/or surface mount
- Powder coated finish and ships fully assembled
- Fully welded
- See page 97 for color options

	2 FOOT	4 FOOT	6 FOOT	8 FOOT
52 SERIES	—	02B- 52-HX4	02B- 52-HX6	02B-52-HX8
53 SERIES	02B-53-HX2	02B- 53-HX4	02B- 53-HX6	02B-53-HX853-HX2



50SM-HX Madison Table with 4 Chairs, spartan bronze

50 | MADISON TABLE WITH 4 CHAIRS

- Features solid powder coated table top with four chairs
- Chairs feature both 1-1/2" and 1" square tubing
- Chairs can also be purchased separately without the table
- Portable and/or surface mount
- See page 97 for color options

TABLE WITH 4 CHAIRS	CHAIR
50SM-HX	53-HX2



01R-51-HXFT Madison Receptacle, fl at top lid, spartan bronze with burgundy backing

01R-51 | H X MADISON RECEPTACLE

- See page 43 for more information

FLAT TOP	ASH URN	RAIN BONNET
01R-51-HXFT	01R-51-HXFT	01R-51-HXRB



02B-61S-CDR6 6' Richmond Bench with Back, cedar style recycled plastic planks, black frame



02B-62SM-CDR6 6' Richmond Bench, cedar style recycled plastic planks, black frame

02B-61/62 | SAHARA BENCH

- 6' length
- Features 3" square tubing legs
- Available with (61) and without back (62)
- Recycled plastic planks with powder coated frame finish
- Available in Steel with (81) and without back (82)
- Inground (S) or surface mount (SM)
- See page 95 for plank color options

61 SERIES	62 SERIES	81 BENCH	82 BENCH
02B-61-GRY6	02B-62-GRY6	02B-81-HS6	02B-82-HS6
02B-61-CDR6	02B-62-CDR6	02B-81C-HS6	02B-82C-HS6
02B-61-BRN6	02B-62-BRN6B	—	—
02B-61-GRN6	02B-62-GRN6	—	—



63SM-HS6 Richmond Table, black

63 | SAHARA TABLE

- 6' length only
- 4" x 4" x 11 ga structural steel tubing
- Stainless steel hardware
- All MIG welded
- Available in recycled plastic as multi pedestal (63) or portable table (64)
- Powder coated finish
- Inground (S) or surface mount (SM)
- See page 97 for color options

63 SERIES	63S-HS6	63SM-HS6	63-GRY6	63-CDR6	63-BRN6	63-GRN6
64 SERIES	—	—	64-GRY6	64-CDR6	64-BRN6	64-GRN6



01R-60-CDR34- Richmond Trash Receptacle, cedar recycled plastic planks

01R-60 | SAHARA TRASH RECEPTACLE

- See page 66 for more information

TRASH RECEPTACLE

01R-60-CDR34



BROOKLYN
COLLECTION

02B-15-P6 6' Brooklyn Bench without back, green



NEW 02B-1 5 | BROOKLYN BENCH

- 2', 4' and 6' lengths available
- Portable and/or surface mount
- Powder coated finish and ships fully assembled
- Fully welded
- See page 97 for color options

	2 FOOT	4 FOOT	6 FOOT
14 SERIES	02B- 14-P2	—	—
15 SERIES	02B- 15-P2	02B-15-P4	02B-15-P6



NEW 02B-1 4 | BROOKLYN BENCH

- Available in modular option
- Portable and/or surface mount
- Powder coated finish and ships fully assembled
- Fully welded
- See page 97 for color options



02B-86-S6 6' Carmel Bench with Back, ultra blue



02B-86-S6 6' Carmel Bench with Back, ultra blue

02B-8 6 | CARMEL BENCH WITH BACK

- 4' and 6' lengths
- Fully welded design
- UltraCoat thermoplastic finish
- 7 gauge steel seat with 3/8" steel plate legs
- Portable and/or surface mount
- See page 97 for color options

4 FOOT	6 FOOT
02B-86-S4	02B-86-S6



02B-85-S6 6' Carmel Bench without Back, ultra blue

02B-8 5 | CARMEL BENCH WITHOUT BACK

- 4' and 6' lengths
- UltraCoat thermoplastic finish
- 7 gauge steel seat with 3/8" steel plate legs
- Fully welded design
- Portable and/or surface mount
- See page 97 for color options

4 FOOT	6 FOOT
02B-85-S4	02B-85-S6



01R-OX-36FT Carmel Receptacle, ultra blue vertical slat with matching flat top lid

01R-OX-3 6 | CARMEL RECEPTACLE

- See page 45 for more information

FLAT TOP	ASH URN	RAIN BONNET
01R-OX-36FT	01R-OX-36AU	01R-OX-36RB

MONTEREY
COLLECTION



02B-43SM-S6 6' Monterey Bench with Back, black



02B-44SM-S6 6' Monterey Bench without Back, black

02B-4 3 / 4 4 | MONTEREY BENCH

- 6' length
- Powder coated finish
- Available with (43) or without back (44)
- Inground (S) or surface mount (SM)
- See page 97 for color options

6 FOOT

43 SERIES	02B- 43-S6
44 SERIES	02B- 44-S6



40SM-S Monterey Square Pedestal Table with 4 seats, black



42-RDS Monterey Round Solid Top Table with 3 seats, black

4 0 / 4 2 | MONTEREY TABLE

- Choose between the single pedestal square table with four seats (40) or the round table with three seats (42)
- Series 40 features a rolled slat table top and series 42 features a solid top
- Features seats that are fabricated from a 1/4" steel plate with rolled slats
- Powder coated finish
- The 40 is available inground (S) or surface mount (SM), the 42 can be portable and/or surface mount
- See page 97 for color options

	SURFACE MOUNT	INGROUND
40 SERIES	40SM-S	40S-S
42 SERIES	42-RDS	—

See page 43 for matching Monterey Receptacle

**FLORENCE
COLLECTION**



964-S6-02B 6' Florence Bench with Back, slat, black



02B-964-S6 6' Florence Bench with Back, slat, green

02B-964 | FLORENCE BENCH WITH BACK

- 4', 6', and 8' lengths
- Thermoplastic finish
- 1-1/2" thick cast aluminum frame
- All stainless steel hardware
- Portable and/or surface mount
- Use code (AO) for add-on sections
- Optional Center Arm Kit available and sold separately
- See page 97 for color options and 98 for pattern options

4 FOOT	6 FOOT	8 FOOT
02B-964-V4	02B-964-V6	02B-964-V8
02B-964-P4	02B-964-P6	02B-964-P8
02B-964-FB4	02B-964-FB6	02B-964-FB8
02B-964-W4	02B-964-W6	02B-964-W8
02B-964-S4	02B-964-S6	02B-964-S8

Also available with recycled planks - see pg. 95



02B-968-S4 4' Florence Bench without Back, wave, green

02B-968 | FLORENCE BENCH WITHOUT BACK

- 4', 6', and 8' lengths
- Thermoplastic finish
- 1-1/2" thick cast aluminum frame
- All stainless steel hardware
- Portable and/or surface mount
- Use code (AO) for add-on sections
- See page 97 for color options and 96 for pattern options

4 FOOT	6 FOOT	8 FOOT
02B-968-V4	02B-968-V6	02B-968-V8
02B-968-P4	02B-968-P6	02B-968-P8
02B-968-FB4	02B-968-FB6	02B-968-FB8
02B-968-W4	02B-968-W6	02B-968-W8
02B-968-S4	02B-968-S6	02B-968-S8

MASON LEE
COLLECTION

02B-99-S6 6' Mason Lee Bench with Back, vertical slats, silver



02B-99-S6 - Mason Lee Bench with Back, black vertical slats

02B-99 | MASON LEE BENCH WITH BACK

- 4' and 6' lengths available
- Available in horizontal or vertical powder coated metal slats
- Also available in 2" x 4" recycled slats
- Cast aluminum frame
- Portable and/or surface mount
- See page 97 for color options

4 FOOT

99-HS4-02B

02B-99-GRY4

02B-99-CDR4

02B-99-BRN4

02B-99-GRN4

6 FOOT

99-HS6

02B-99-GRY6

02B-99-CDR6

02B-99-BRN6

02B-99-GRN6



02B-98-S4 4' Mason Lee Bench without Back, vertical slats, blue powder coated finish, black frame

02B-98 | MASON LEE BENCH WITH BACK

- 4' and 6' lengths available
- Available vertical powder coated metal slats
- Cast aluminum frame
- Also available in 2" x 4" recycled slats
- Portable and/or surface mount
- See page 97 for color options

4 FOOT

02B-98-S4

02B-98-GRY4

02B-98-CDR4

02B-98-BRN4

02B-98-GRN4

6 FOOT

02B-98-S6

02B-98-GRY6

02B-98-CDR6

02B-98-BRN6

02B-98-GRN6

CAMPUS COMMONS
COLLECTION



954-FB6 Lexington Bench with Back, Fiesta, black



02B-954-V6 6' Lamarche Bench with Back, diamond

02B-954 | LAMARCHE BENCH WITH BACK

- 4', 6', and 8' lengths
- UltraCoat® thermoplastic finish
- 1-1/2" thick cast aluminum frame
- All stainless steel hardware
- Portable and/or surface mount
- Add-ons optional (Example: 954AO-V4)
- Optional Center Arm Kit available and sold separately
- See page 97 for color options and 96 for pattern options

4 FOOT	6 FOOT	8 FOOT
02B-954-V4	02B-954-V6	02B-954-V8
02B-954-P4	02B-954-P6	02B-954-P8
02B-954-FB4	02B-954-FB6	02B-954-FB8
02B-954-W4	02B-954-W6	02B-954-W8
02B-954-S4	02B-954-S6	02B-954-S8

02B-958 | LAMARCHE BENCH WITHOUT BACK

- 4', 6', and 8' lengths
- UltraCoat® thermoplastic finish
- 1-1/2" thick cast aluminum frame
- All stainless steel hardware
- Portable and/or surface mount
- Add-ons optional (Example: 958AO-V4)
- See page 97 for color options and 96 for pattern options



02B-958-S6 6' Lamarche Bench without Back, slat

4 FOOT	6 FOOT	8 FOOT
02B-958-V4	02B-958-V6	02B-958-V8
02B-958-P4	02B-958-P6	02B-958-P8
02B-958-FB4	02B-958-FB6	02B-958-FB8
02B-958-W4	02B-958-W6	02B-958-W8
02B-958-S4	02B-958-S6	02B-958-S8

See page 49 for matching Lexington Planter



O2B-72-16 6' 5th Avenue Bench with Ipe Wood, spartan bronze frame



O2B-71-S6 6' 5th Avenue Bench with Powder Coated Finish, matte black

O2B-7 1/72 /73 | 5th AVENUE BENCH

- 4', 6', and 8' lengths available
- 3/4" steel plate legs reinforced with 1/4" thick support bars
- Powder coated steel slats are 1/4" x 5"
- Available with (71) and without back (73)
- Without back option also available without armrests (72)
- Portable and/or surface mount
- See page 97 for color options

	4 FOOT	6 FOOT	8 FOOT
71 SERIES	O2B- 71-S4	O2B- 71-S6	O2B- 71-S8
72 SERIES	O2B- 72-S4	O2B-72-S6	O2B- 72-S8
73 SERIES	O2B- 73-S4	O2B-73-S6	O2B-73-S8

O2B-7 1/72 /73 | 5th AVENUE BENCH WITHOUT BACK



O2B-72-16 6' 5th Avenue Bench with Ipe Wood, no armrests, spartan bronze frame

- 4', 6', and 8' lengths available
- 3/4" steel plate legs reinforced with 1/4" thick support bars
- Ipe wood comes in 1-1/4" x 6" planks and are cut to length and predrilled
- Planks are sealed on each end to prevent splitting and stained with a wood finish
- Available with (71) and without back (73)
- Without back option also available without armrests (72)
- Portable and/or surface mount

	4 FOOT	6 FOOT	8 FOOT
71 SERIES	O2B- 71-14	O2B- 71-16	O2B- 71-18
72 SERIES	O2B- 72-14	O2B- 72-16	O2B- 72-18
73 SERIES	O2B- 73-14	O2B- 73-16	O2B- 73-18

AUGUSTUS
COLLECTION



800-RS3-02B Augustus Bench, 3-seat, black



02B-800-RS3 Augustus Bench, 3-seat, black

02B-800 | AUGUSTUS BENCH

- 2, 3, and 4 seat options
- Powder coated finish
- Manufactured with 5/8" steel rods
- 23" wide seats
- All stainless steel hardware
- Portable (P), surface mount (SM), or inground (S)
- See page 97 for color options

2 SEAT	3 SEAT	4 SEAT
02B-800-RS2	02B-800-RS3	02B-800-RS4



01R-SV-R32FT Augustus Trash Receptacle with Flat Top, black

01R-SV-R32 | AUGUSTUS TRASH RECEPTACLE

- 32 gallon capacity
- 29" square x 33-3/16" high
- Powder coated finish
- Manufactured with 5/8" steel rods
- Portable (P) or surface mount (SM)
- Liner and lid included
- See page 97 for color options

FLAT TOP LID	ASH URN LID	RAIN BONNET LID
01R-SV-R32FT	01R-SV-R32AU	01R-SV-R32RB

LIONCAOT COLLECTION
BENCHES





Check out our
Buddy Bench
options on
pg. 52

02B-940-P6-BB 6' Extra Heavy Duty Bench with Back, inground, blue perforated rolled seating pattern, black frame



02B-940P-P6 Extra Heavy-Duty Bench with Back, portable, green perforated pattern, black frame

02B-940 | EXTRA HEAVY-DUTY BENCH WITH BACK

The 940 Bench continues to be the most popular series.

- Available in 6', 8', 10', and 15' lengths
- 12" seating standard or optional deluxe (D) 15" seating
- Thermoplastic finish with powder coated frame
- 2-3/8" O.D. all MIG welded frame
- 1" O.D. brace (Portable frame only)
- All stainless steel hardware
- Portable (P), inground (S), surface mount (SM), or wall mount (WM)
- Cover Plates available for inground (S) and surface mount (SM)
- Optional Center Arm Kit available and sold separately
- See page 97 for color options and 96 for seating patterns

6 FOOT	12" seating	(D) 15" seating
	02B-940-V6	02B-940-DV6
	02B-940-P6	02B-940-DP6
	02B-940-FV-02B (frame only)	

8 FOOT	12" seating	(D) 15" seating
	02B-940-V8	02B-940-DV8
	02B-940-P8	02B-940-DP8
	02B-940-FV (frame only)	

10 FOOT	12" seating	(D) 15" seating
	02B-940-V10	02B-940-DV10
	02B-940-P10	02B-940-DP10
	02B-940-FV10 (10' frame only)	

15 FOOT	12" seating	(D) 15" seating
	02B-940-V15	02B-940-DV15
	02B-940-P15	02B-940-DP15
	02B-940-FV15 (15' frame only)	



02B-942S-V15 15' Extra Heavy-Duty Bench without Back, inground, blue diamond pattern, black frame



02B-942SM-P6 6' Extra Heavy-Duty Bench without Back, surface mount, green perforated pattern, black frame

02B-942 | EXTRA HEAVY-DUTY BENCH WITHOUT BACK

- Available in 6', 8', 10', and 15' lengths
- 12" seating standard or optional deluxe (D) 15" seating
- Thermoplastic finish with powder coated frame
- 2-3/8" O.D. all MIG welded frame
- 1" O.D. brace (Portable frame only)
- All stainless steel hardware
- Portable (P), inground (S), surface mount (SM), or wall mount (WM)
- Cover Plates available for inground (S) and surface mount (SM)
- Optional Center Arm Kit available and sold separately
- See page 97 for color options and 96 for seating patterns

10 FOOT	12" seating	(D) 15" seating
	02B-942-V10	02B-942-DV10
942-P10	02B-942-DP10	
	942-FV10 (10' frame only)	

15 FOOT	12" seating	(D) 15" seating
	942-V15-02B	02B-942-DV15
942-P15-02B	942-DP15-02B	
	02B-942-FV15 (15' frame only)	

6 FOOT	12" seating	(D) 15" seating
	02B-942-V6	02B-942-DV6
02B-942-P6	02B-942-DP6	
	02B-942-FV (frame only)	

8 FOOT	12" seating	(D) 15" seating
	02B-942-V8	02B-942-DV8
02B-942-P8	02B-942-DP8	
	02B-942-FV (frame only)	



02B-970-V6 6' Cantilevered Bench, inground, blue diamond pattern, black frame

02B-970 | CANTILEVERED BENCH

- Available in 4', 6', and 8' lengths
- Thermoplastic finish with powder coated frame
- Heavy-duty 2-3/8" O.D. all MIG welded frame
- All stainless steel hardware
- Inground mount only
- See page 97 for color options and 96 for seating patterns

4 FOOT	6 FOOT	8 FOOT
02B-970-V4	02B-970-V6	02B-970-V8
02B-970-P4	02B-970-P6	02B-970-P8
02B-970-FB4	02B-970-FB6	02B-970-FB8
02B-970-W4	02B-970-W6	02B-970-W8
02B-970-S4	02B-970-S6	02B-970-S8



932SM-P6-02B 6' Mall Bench, surface mount, blue perforated pattern, black frame



02B-934SM-V6 6' Geometric Mall Bench, surface mount, green diamond pattern, black frame

02B-934 | GEOMETRIC MALL BENCH

The Geometric Mall Bench (934) is designed to fit around objects or create geometric designs.

- Available in 6' and 8' lengths
- 6' Bench has 32" square center, 8' Bench has 56" square center
- 20" deep seat with 4" tall outside border
- Thermoplastic finish with powder coated frame
- 4" bollard-style square tubing
- All stainless steel hardware
- Inground (S) or surface mount (SM)
- Seating pattern options: perforated, diamond
- See page 97 for color options

6 FOOT	8 FOOT
02B-934-V6	02B-934-V8
02B-934-P6	02B-934-P8



02B-932SM-V6 6' Mall Bench, surface mount, blue diamond pattern, black frame

02B-932 | MALL BENCH

- Available in 4', 6', and 8' lengths
- 15" deep seat with 4" tall outside border
- Thermoplastic finish with powder coated frame
- All stainless steel hardware
- Inground (S) or surface mount (SM)
- Seating pattern options: perforated, diamond, wave
- See page 97 for color options

4 FOOT	6 FOOT	8 FOOT
02B-932-V4	02B-932-V6	02B-932-V8
02B-932-P4	02B-932-P6	02B-932-P8
02B-932-W4	02B-932-W6	02B-932-W8

See pg. 38 for matching table.



02B-965SM-W4 4' Contour Bench with Back, surface mount, black wave pattern, spartan bronze frame



02B-965SM-FB6 6' Contour Bench with Back, surface mount, blue fiesta pattern, black frame

02B-965 | CONTOUR BENCH WITH BACK

- 4', 6', and 8' lengths can be extended with 4', 6', or 8' add-on (AO) benches
- Thermoplastic finish with powder coated frame
- 2-3/8" O.D. frame
- All stainless steel hardware
- Portable (P), inground (S), or surface mount (SM)
- Cover Plate available for inground (S) or surface mount (SM)
- Optional Center Arm Kit available and sold separately
- See page 97 for color options and 96 for seating patterns

4 FOOT	6 FOOT	8 FOOT
02B-965-V4	02B-965-V6	02B-965-V8
02B-965-P4	02B-965-P6	02B-965-P8
02B-965-FB4	02B-965-FB6	02B-965-FB8
02B-965-W4	02B-965-W6	02B-965-W8
02B-965-S4	02B-965-S6	02B-965-S8



02B-966SM-P6 6' Contour Bench without Back, surface mount, green perforated pattern, black frame

02B-966 | CONTOUR BENCH WITHOUT BACK

- 4', 6', and 8' lengths can be extended with 4', 6', or 8' add-on (AO) benches
- Thermoplastic finish with powder coated frame
- 2-3/8" O.D. frame
- All stainless steel hardware
- Portable (P), inground (S), or surface mount (SM)
- Cover Plate available for inground (S) or surface mount (SM)
- See page 97 for color options and 96 for seating patterns

4 FOOT	6 FOOT	8 FOOT
02B-966-V4	02B-966-V6	02B-966-V8
02B-966-P4	02B-966-P6	02B-966-P8
02B-966-FB4	02B-966-FB6	02B-966-FB8
02B-966-W4	02B-966-W6	02B-966-W8
02B-966-S4	02B-966-S6	02B-966-S8



02B-967-V6- 6' Contour Bench Swing, blue diamond pattern, black frame

02B-967 | CONTOUR BENCH SWING

- Available in 4' and 6' lengths
- 2-3/8" O.D. frame
- Thermoplastic finish with powder coated frame
- Uncoated galvanized swing chain
- Cover Plate available
- All stainless steel hardware
- Inground (S) mount only
- See page 97 for color options and 96 for seating patterns

4 FOOT	6 FOOT
02B-967-V4	02B-967-V6
02B-967-P4	02B-967-P6
02B-967-FB4	02B-967-FB6
02B-967-W4	02B-967-W6
02B-967-S4	02B-967-S6

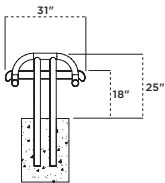

02B-976SM-V4 4' Contour Cantilevered Bench without Back, surface mount, blue diamond pattern, black frame

02B-976 | CONTOUR CANTILEVERED BENCH WITHOUT BACK

- Available in 4', 6', and 8' lengths and can be extended with 4', 6', or 8' add-on (AO) benches
- Thermoplastic finish with powder coated frame
- Heavy-duty 2-3/8" O.D. all MIG welded frame
- All stainless steel hardware
- Inground (S) or surface mount (SM)
- See page 97 for color options and 96 for seating patterns

4 FOOT	6 FOOT	8 FOOT
02B-976-V4	02B-976-V6	02B-976-V8
02B-976-P4	02B-976-P6	02B-976-P8
02B-976-FB4	02B-976-FB6	02B-976-FB8
02B-976-W4	02B-976-W6	02B-976-W8
02B-976-S4	02B-976-S6	02B-976-S8



02B-975SM-W6 6' Contour Cantilevered Bench with Back, surface mount, red wave pattern, white frame

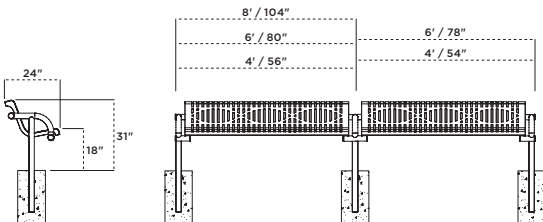

02B-975 | CONTOUR CANTILEVERED BENCH WITH BACK

- Available in 4', 6', and 8' lengths and can be extended with 4', 6', or 8' add-on (AO) benches
- Thermoplastic finish with powder coated frame
- Heavy-duty 2-3/8" O.D. all MIG welded frame
- All stainless steel hardware
- Inground (S) or surface mount (SM)
- See page 97 for color options and 96 for seating patterns

4 FOOT	6 FOOT	8 FOOT
02B-975-V4	02B-975-V6	02B-975-V8
02B-975-P4	02B-975-P6	02B-975-P8
02B-975-FB4	02B-975-FB6	02B-975-FB8
02B-975-W4	02B-975-W6	02B-975-W8
02B-975-S4	02B-975-S6	02B-975-S8



962SM-V6-02B 6' Double-Sided Bollard Bench, surface mount, green diamond pattern, green frame



02B-962SM-V6 6' Double-Sided Bollard Bench, surface mount, ultra blue diamond pattern, ultra blue frame

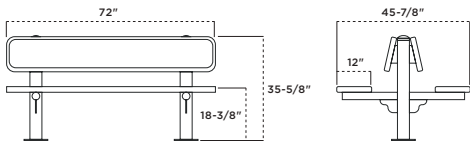

02B-962 | BOLLARD STYLE BENCH

- Available in 6' and 8' lengths
- Thermoplastic finish with powder coated frame
- 4" bollard-style square post
- 2-3/8" O.D. all MIG welded seat support arm
- All stainless steel hardware
- Inground (S) or surface mount (SM)
- Seating pattern options: perforated, perforated rolled, diamond, diamond rolled
- See page 97 for color options

6 FOOT	8 FOOT
02B-962-V6	02B-962-V8
02B-962-VR6	02B-962-VR8
02B-962-P6	02B-962-P8
02B-962-PR6	02B-962-PR8



02B-961SM-V6 6' Single-Sided Bollard Bench, surface mount, red diamond pattern, black frame

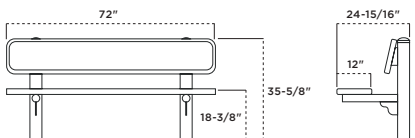

02B-961 | BOLLARD STYLE BENCH

- Available in 6' and 8' lengths
- Thermoplastic finish with powder coated frame
- 4" bollard-style square post
- 2-3/8" O.D. all MIG welded seat support arm
- All stainless steel hardware
- Inground (S) or surface mount (SM)
- Seating pattern options: perforated, perforated rolled, diamond, diamond rolled
- See page 97 for color options

6 FOOT	8 FOOT
02B-961-V6	02B-961-V8
02B-961-VR6	02B-961-VR8
02B-961-P6	02B-961-P8
02B-961-PR6	02B-961-PR8



02B -800P-VS3-3-Seat Straight Bench with Back, portable, brown diamond pattern, brown frame

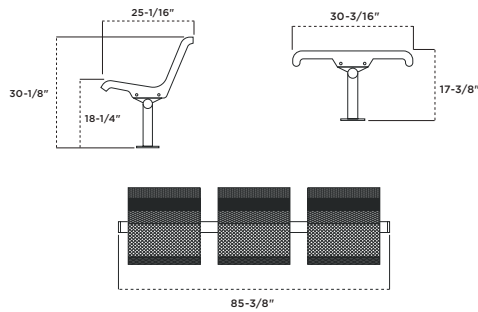

02B-800/700 | STRAIGHT BENCH

- Thermoplastic finish with powder coated frame
- 2-3/8" O.D. all MIG welded frame
- 1-5/8" O.D. feet (portable only)
- All stainless steel hardware
- Portable (P), inground (S), or surface mount (SM)
- Available with (800) or without (700) back
- Available in 2 or 3 individual seat sections
- Seating pattern options: perforated, diamond, rod
- See page 97 for color options

WITH BACK	2 SEAT		3 SEAT		W/O BACK	2 SEAT		3 SEAT	
	02B-800-VS2	02B-800-VS3	02B-700-VS2	02B-700-VS3		02B-800-PS2	02B-800-PS3	02B-700-PS2	02B-700-PS3
	02B-800-RS2	02B-800-RS3	02B-700-RS2	02B-700-RS3		02B-800-RS2	02B-800-RS3	02B-700-RS2	02B-700-RS3



02B -715SM-VCA3-3-Seat Concave Bench without Back, surface mount, green diamond pattern, black frame

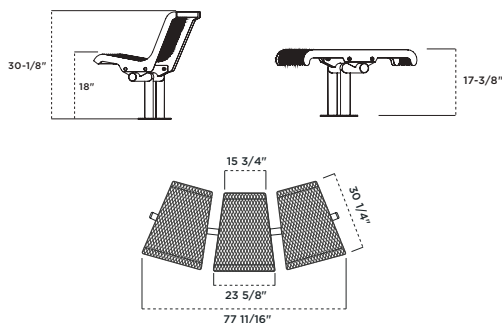

02B - 815 / 715 | CONCAVE AND CONVEX BENCHES
02B- 830 / 730

The 3-seat 815 & 715 series has 15° angles, while the 830 & 730 series has 30° angles. This allows the seating to be placed in a semi-circular arrangement.

- Thermoplastic finish with powder coated frame
- 2-3/8" O.D. all MIG welded main support
- 1-5/8" O.D. feet (portable only)
- All stainless steel hardware
- Portable (P), inground (S), or surface mount (SM)
- Series 815 & 830 are with backs
- Series 715 & 730 are without backs
- Seating pattern options: perforated, diamond
- See page 97 for color options

815 / 715		830 / 730	
WITH BACK	W/O BACK	WITH BACK	W/O BACK
02B-815-VCX3	02B-715-VCX3	02B-830-VCX3	02B-730-VCX3
02B-815-PCX3	02B-715-PCX3	02B-830-PCX3	02B-730-PCX3
02B-815-PCA3	02B-715-PCA3		

BENCHES



O2B-955SM-W6 6' Sierra Bench, surface mount, red wave pattern, red frame

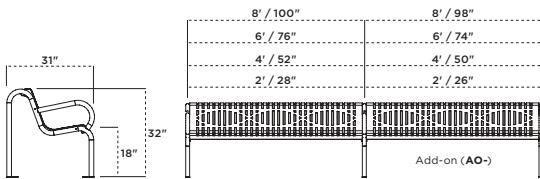

O2B-955 | SIERRA BENCH

- Available in 2', 4', 6', and 8' with optional add-on (AO) benches
- Thermoplastic finish with powder coated frame
- 1-5/8" O.D. all MIG welded frame
- All stainless steel hardware
- Portable (P), inground (S), or surface mount (SM)
- Optional Center Arm Kit available and sold separately
- See page 97 for color options and 96 for seating patterns

BENCH	2 FOOT	4 FOOT	6 FOOT	8 FOOT
	955-V24-02B	955-V4-02B	955-V6-02B	955-V8-02B
955-P24-02B	955-P4-02B	955-P6-02B	955-P8-02B	
955-FB24-02B	955-FB4-02B	955-FB6-02B	955-FB8-02B	
955-W24-02B	955-W4-02B	955-W6-02B	955-W8-02B	
955-S24-02B	955-S4-02B	955-S6-02B	955-S8-02B	

ADD-ON	2 FOOT	4 FOOT	6 FOOT	8 FOOT
	955AO-V24-02B	955AO-V4-02B	955AO-V6-02B	955AO-V8-02B
955AO-P24-02B	955AO-P4-02B	955AO-P6-02B	955AO-P8-02B	
955AO-FB24-02B	955AO-FB4-02B	955AO-FB6-02B	955AO-FB8-02B	
955AO-W24-02B	955AO-W4-02B	955AO-W6-02B	955AO-W8-02B	
955AO-S24-02B	955AO-S4-02B	955AO-S6-02B	955AO-S8-02B	



O2B-950P-V6- 6' Capri Bench, portable, black diamond rolled pattern, black frame

O2B-950 | CAPRI BENCH

- Available in 4', 6', and 8' lengths
- Thermoplastic finish with powder coated frame
- Heavy-duty 2-3/8" O.D. all MIG welded frame
- All stainless steel hardware
- Portable (P), inground (S), or surface mount (SM)
- See page 97 for color options and 96 for seating patterns

4 FOOT	6 FOOT	8 FOOT
O2B-950-V4	O2B-950-V6	O2B-950-V8
O2B-950-P4	O2B-950-P6	O2B-950-P8
O2B-950-FB4	O2B-950-FB6	O2B-950-FB8
O2B-950-W4	O2B-950-W6	O2B-950-W8
O2B-950-S4	O2B-950-S6	O2B-950-S8



O2B-963-V6 Contour Bench, portable, blue diamond pattern, black frame

O2B-963 | CONTOUR BENCH

- Available in 4' and 6' lengths
- Thermoplastic finish with powder coated frame
- Heavy-duty 2-3/8" O.D. all MIG welded frame
- All stainless steel hardware
- Portable (P), inground (S), or surface mount (SM)
- See page 97 for color options

4 FOOT	6 FOOT
O2B-963-V4	O2B-963-V6



02B-955-W6-LL 6' Sierra Bench, red wave pattern, black frame, custom laser lettering



02B-96-S6-6' Jackson Bench, black slat pattern, black frame

02B-96 | JACKSON BENCH WITH BACK

This powder coated bench features a bolt Bolt-Thru design for easy installation and a high end look.

- Available in 4', 6', and 8' lengths
- Powder coated frame and slats
- 1-1/2" square tubing frame
- All stainless steel hardware
- Portable and/or surface mount
- See page 97 for powder coat color options
- Seating pattern: slat only
- See page 46 for matching receptacle

4 FOOT	6 FOOT	8 FOOT
02B-P96-S4	02B-P96-S6	02B-P96-S8

02B-95 | JACKSON BENCH WITHOUT BACK

This powder coated bench features a Bolt-Thru design for easy installation and a high end look.

- Available in 4', 6', and 8' lengths
- Powder coated frame and slats
- 1-1/2" square tubing frame
- All stainless steel hardware
- Portable and/or surface mount
- See page 97 for powder coat color options
- Seating pattern: slat only
- See page 46 for matching receptacle

4 FOOT	6 FOOT	8 FOOT
02B-P95-S4	02B-P95-S6	02B-P95-S8



02B-95-S6 6' Jackson Bench, black slat pattern, black frame

See page 46 for matching receptacle.

ULTRACOAT COLLECTION
—
TABLES



358-RDV 46" Round Table, ultra blue diamond pattern, ultra blue frame



358H-P-GT 46" Square Table with optional game top, blue perforated pattern, black frame

358 | SQUARE, OCTAGON, & ROUND TABLE

- 46" square, octagon, or round table with 1-9/16" I.D. umbrella hole standard
- Thermoplastic finish with powder coated frame
- 1-5/8" O.D. frame with 1" O.D. brace
- All MIG welded frame with walk-through design
- All stainless steel hardware
- Portable and/or surface mount
- Game top option available (add GT)
- See page 97 for color options and 96 for patterns



358-RDV 46" Round Table, green diamond pattern, black frame

SQUARE	SQUARE W/ GAME TOP	OCTAGON	OCTAGON W/ GAME TOP	ROUND	ROUND W/ GAME TOP
358-V	358-V-GT	358-OV	358-OV-GT	358-RDV	358-RDV-GT
358-P	358-P-GT	358-OP	358-OP-GT	358-RDP	358-RDP-GT
358-VR	358-VR-GT	358-OVR	358-OVR-GT	—	—
358-PR	358-PR-GT	358-OPR	358-OPR-GT	—	—

358H | 3-SEAT TABLES

- Open end allows for wheelchair access
- All stainless steel hardware
- Surface mount recommended
- See page 97 for color options and 96 for seating patterns



SQUARE	OCTAGON	ROUND
358H-V	358H-OV	358H-RDV
358H-P	358H-OP	358H-RDP
358H-VR	358H-OVR	—
358H-PR	358H-OPR	—



238-V6 6' Extra Heavy-Duty Rectangular Table, blue diamond pattern, black frame



238-V8 8' Extra Heavy-Duty Rectangular Table, brown diamond pattern, white frame

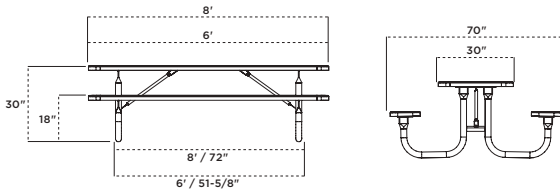

238 | EXTRA HEAVY-DUTY
RECTANGULAR TABLE

- 4', 6' and 8' lengths
- Thermoplastic finish with powder coated frame
- 2-3/8" O.D. frame with 1" O.D. brace
- All MIG welded frame with walk-through designs
- All stainless steel hardware
- Portable and/or surface mount
- Umbrella hole option is available for 6' and 8' tables
- See page 97 for color options and 96 for patterns

4 FOOT	6 FOOT	8 FOOT
238-V4	238-V6	238-V8
238-P4	238-VR6	238-VR8
—	238-P6	238-P8
—	238-PR6	238-PR8
—	238-FV (frame only)	238-FV (frame only)
—	238-V6U (with umbrella hole)	238-V8U (with umbrella hole)



238H-V8 8' Double-Sided ADA Accessible Table, red diamond pattern, black frame

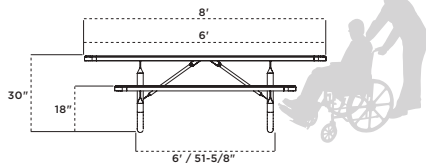

238H | EXTRA HEAVY-DUTY
8' ADA ACCESSIBLE TABLE 

- Available in an 8' ADA Accessible option with choice of single or double-sided accessibility
- Thermoplastic finish with powder coated frame
- 2-3/8" O.D. frame with 1" O.D. brace
- All MIG welded frame with walk-through designs
- All stainless steel hardware
- Portable and/or surface mount
- See page 97 for color options and 96 for patterns

ADA Double-Sided	ADA Single-Sided
238H-V8	238HS-V8
238H-VR8	238HS-VR8
238H-P8	238HS-P8
238H-PR8	238HS-PR8
238H-FV (frame only)	238HS-FV (frame only)



238H-3-V12 12' ADA Shelter Table, portable, red diamond pattern, black frame

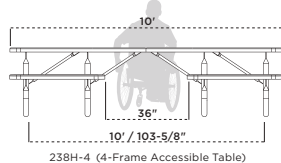
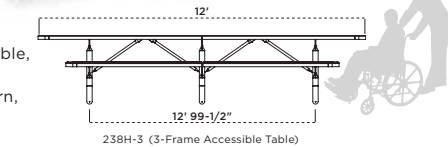

238H | EXTRA HEAVY-DUTY ADA SHELTER TABLE 

- Available in 10' length with 4 frames or 12' length with 3 frames
- ADA accessible
- Thermoplastic finish with powder coated frame
- 2-3/8" O.D. all MIG welded frame
- Features walk-through design
- 1" O.D. brace
- All stainless steel hardware
- Portable and/or surface mount
- See page 97 for color options and 96 for patterns

10 FOOT, 4-FRAME	12 FOOT, 3-FRAME
238H-4-V10	238H-3-V12
238H-4-P10	238H-3-P12
238H-4-FV (frame only)	238H-3-FV (frame only)



238HS-V6 6' Extra Heavy-Duty Single Sided ADA Table, portable, green diamond pattern, black frame



238HS | EXTRA HEAVY-DUTY SINGLE SIDED ADA TABLE 

- Available in 6' length
- ADA accessible
- Thermoplastic finish with powder coated frame
- 2-3/8" O.D. all MIG welded frame
- Features walk-through design
- 1" O.D. brace
- All stainless steel hardware
- See page 97 for color options and 96 for patterns

6 FOOT	8 FOOT
238HS-P6*	238HS-V8
238HS-V6*	238HS-VR8
—	238HS-P8
—	238HS-PR8
—	238HS-FV (frame only)

*Must be installed with surface mount clamps or inground post.



238-3-V10 10' Shelter Table, brown diamond pattern, black frame

238-3 | EXTRA HEAVY-DUTY SHELTER TABLE

- Available in 10' or 12' lengths with 3 frames
- Thermoplastic finish with powder coated frame
- 2-3/8" O.D. frame with 1" O.D. brace
- All MIG welded frame with walk-through designs
- All stainless steel hardware
- Portable and/or surface mount
- Includes 2 sections and 3 legs for added support
- See page 97 for color options and 96 for patterns

10 FOOT, 3-FRAME	12 FOOT, 3-FRAME
238-3-V10	238-3-V12
238-3-P10	238-3-P12
238-3-FV (frame only)	238-3-FV (frame only)

TABLES



158-P8 8' Heavy-Duty Rectangular Table, black perforated pattern, black frame

158 | HEAVY-DUTY RECTANGULAR TABLE

- 4', 6', and 8' lengths with walk-through design
- Thermoplastic finish with powder coated frame
- 1-5/8" O.D. all MIG welded frame
- 1" O.D. brace
- All stainless steel hardware
- Portable and/or surface mount
- See page 97 for color options and 96 for patterns

4 FOOT	6 FOOT	8 FOOT
158-V4	158-V6	158-V8
158-P4	158-VR6	158-VR8
—	158-P6	158-P8
—	158-PR6	158-PR8
—	158-FV (frame only)	158-FV (frame only)



158H-V8 8' Heavy-Duty Rectangular Table, red diamond pattern, black frame

158H | HEAVY-DUTY 8' ADA ACCESSIBLE TABLE 

- Available in an 8' ADA accessible option with choice of single or double-sided handicap accessibility
- Thermoplastic finish with powder coated frame
- 1-5/8" O.D. all MIG welded frame
- 1" O.D. brace
- All stainless steel hardware
- Portable and/or surface mount
- See page 97 for color options and 96 for patterns

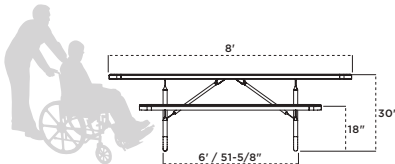

ADA DOUBLE SIDED	ADA SINGLE SIDED
158H-V8	158HS-V8
158H-VR8	158HS-VR8
158H-P8	158HS-P8
158-PR8	158HS-PR8
158-FV (frame only)	158-FV (frame only)



BT158-V6 6' Heavy-Duty Bolt-Thru Rectangular Table, green diamond pattern, black frame

BT158 | HEAVY-DUTY BOLT-THRU TABLE

- Available in 6' and 8' lengths
- Thermoplastic finish with powder coated frame
- 1-5/8" O.D. bolt together frame
- 1" O.D. brace
- All stainless steel hardware
- Portable and/or surface mount
- See page 97 for color options and 96 for patterns

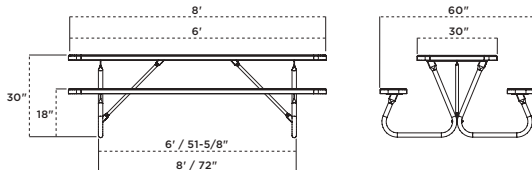

6 FOOT	8 FOOT
BT158-V6	BT158-V8
BT158-VR6	BT158-VR8
BT158-P6	BT158-P8
BT158-PR6	BT158-PR8
BT158-FV (frame only)	BT158-FV (frame only)



230-RDPC-46 46" Round Contour Table, brown perforated pattern, brown frame



BT238-V6 6' Extra Heavy-Duty Bolt-thru Rectangular Table, green diamond pattern, black frame

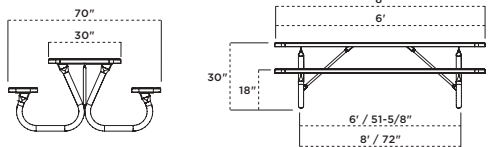

BT238 | EXTRAHEAVY-DUTY BOLT-THRU

- Available in 6' and 8' lengths
- Thermoplastic finish with powder coated frame
- 2-3/8" O.D. all bolt together walk-through frame
- 1" O.D. brace
- All stainless steel hardware
- Portable and/or surface mount
- See page 97 for color options and 96 for patterns

6 FOOT	8 FOOT
BT238-V6	BT238-V8
BT238-VR6	BT238-VR8
BT238-P6	BT238-P8
BT238-PR6	BT238-PR8
BT238-FV (frame only)	BT238-FV (frame only)



230-RDPC-46 46" Round Contour Table, brown perforated pattern, brown frame

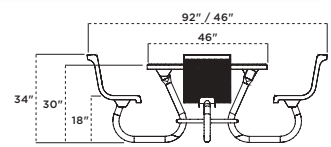

230 | ROUND CONTOUR TABLE

- 46" table top with a standard 1-9/16" dia. umbrella hole
- Thermoplastic finish with powder coated frame
- 2-3/8" O.D. all bolt together walk-through frame
- All stainless steel hardware
- Portable and/or surface mount
- See page 97 for color options and 96 for patterns

46" TABLE	46" 3-SEAT TABLE
230-RDVC46	230H-RDVC46
230-RDPC46	230H-RDPC46



238H-V8 8' Extra Heavy-Duty Bolt-Thru Rectangular Table, green diamond pattern, black frame



337SM-P6 6' Heavy-Duty Rectangular Single Pedestal Table, surface mount, brown perforated pattern, black frame

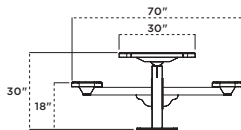

337 | HEAVY-DUTY RECTANGULAR SINGLE PEDESTAL TABLE 

- Available in 4' and 6' lengths with ADA accessibility
- Thermoplastic finish with powder coated frame
- 4" x 4" square post frame with 3" x 3" square support arms
- All MIG welded frame
- All stainless steel hardware
- Inground (S) or surface mount (SM)
- See page 97 for color options and 96 for patterns

4 FOOT	6 FOOT
337-V4	337-V6
337-P4	337-VR6
—	337-P6
—	337-PR6



349S-V6 6' Multi Pedestal Table, inground, ultra blue diamond pattern, black frame

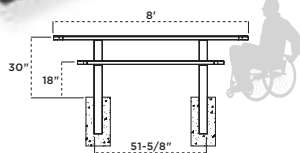

349 | MULTI PEDESTAL TABLE 

- Available in 6', and 8' lengths with ADA accessibility (8' only)
- Thermoplastic finish with powder coated frame
- 4" square post all MIG welded frame with walk-through design
- All stainless steel hardware
- Inground (S) or surface mount (SM)
- See page 97 for color options and 96 for patterns

6 FOOT	8 FOOT	ADA 8 FOOT
349-V6	349-V8	349H-V8
349-P6	349-P8	349H-P8
349-VR6	349-VR8	349H-VR8
349-PR6	349-PR8	349H-PR8



347-P6 6' Rectangular Dual Pedestal Table, green perforated pattern, black frame

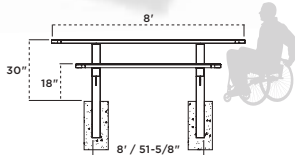

347 | RECTANGULAR DUAL PEDESTAL

- Available in 6' and 8' lengths with ADA accessibility (8' inground mount only)
- Thermoplastic top and seats with powder coated frame
- 4" x 4" square all MIG welded frame and support arms
- All stainless steel hardware
- Inground (S) or surface mount (SM)
- See page 97 for color options and 96 for patterns

6 FOOT	8 FOOT	ADA 8 FOOT
347-V6	347-V8	347H-V8
347-P6	347-P8	347H-P8
347-VR6	347-VR8	347H-VR8
347-PR6	347-PR8	347H-PR8



238U-V6 6' Utility Table, portable, red diamond pattern, black frame

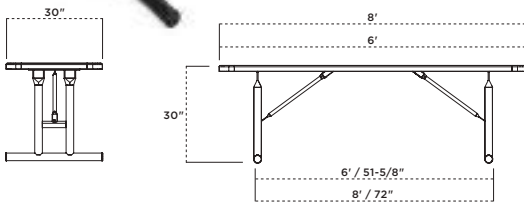

238U | UTILITY TABLE

Utility Tables have an easy access design and are ideal for any park or restaurant.

- Available in 6' and 8' lengths with ADA accessibility
- Thermoplastic finish with powder coated frame
- 2-3/8" O.D. all MIG welded frame
- 1" O.D. brace
- All stainless steel hardware
- Portable only
- See page 97 for color options and 96 for patterns

6 FOOT	8 FOOT
238U-V6	238U-V8
238U-VR6	238U-VR8
238U-P6	238U-P8
238U-PR6	238U-PR8



349SU-V8 8' Utility Table, inground mount, blue diamond pattern, black frame

349U | MULTI PEDESTAL UTILITY TABLE

Utility Tables have an easy access design and are ideal for any park or restaurant.

- Available in 6' and 8' lengths with ADA accessibility
- Thermoplastic finish with powder coated frame
- 4" square post all MIG welded frame with walk-through design
- All stainless steel hardware
- Inground (S) or surface mount (SM)
- See page 97 for color options and 96 for patterns

6 FOOT	8 FOOT
349U-V6	349U-V8
349U-VR6	349U-VR8
349U-P6	349U-P8
349U-PR6	349U-PR8



338S-RDV 46" Round Single Pedestal Table, inground mount, red diamond pattern, black frame



239SM-V 8' Rectangle Lion Outdoor® Span Leg Table, green diamond pattern, black frame

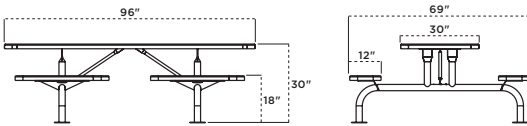

239 | RECTANGULAR LION OUTDOOR® SPAN LEG TABLE

- Span Leg design allows additional legroom and easy clean-up access, ideal for outdoor eating areas
- Available in 8' only
- Thermoplastic finish with powder coated frame
- Frame is made of 2 3/8" O.D. powder coated steel tubing
- All MIG welded frame
- Inground (S) or surface mount (SM)
- Cover plates are available in sets of 2, sold separately
- Pattern options: perforated, perforated rolled, diamond, diamond rolled
- See page 97 for color options

RECTANGLE TABLE

239-VN

239-PR



369SM-V Square Lion Outdoor® Span Leg Table, black diamond pattern, black frame

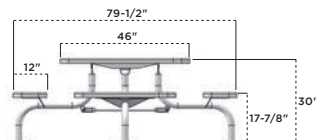

369 | SQUARE SPAN LEG TABLE

- Span Leg design allows additional legroom and easy clean-up access, ideal for outdoor eating areas
- Frame is made of 2 3/8" O.D. powder coated steel tubing
- Thermoplastic finish with powder coated frame
- All MIG welded frame
- Inground (S) or surface mount (SM)
- ADA accessible option available
- Cover plates are available in sets of 2, sold separately
- Pattern options: perforated, diamond, perforated rolled, diamond rolled
- Available in square, round, or octagon shapes
- See page 97 for color options

ROUND TABLE	OCTAGON TABLE	SQUARE TABLE	3-SEAT SQUARE TABLE
369-RDV	369-OV	369-V	369H-V
369-RDP	369-OP	369-P	369H-P
369-RDVR	369-OVR	369-VR	369H-VR
369-RDPR	369-OPR	369-PR	369H-PR



501S-P 1 Seat Canteen Table, red perforated pattern, red frame
 504S-P 4 Seat Canteen Table, red perforated pattern, red frame



501S-P Canteen Table, red perforated pattern, red frame



2 SEAT

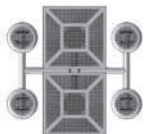

4 SEAT

501 | CANTEEN TABLE

- Single pedestal design allows for easy clean-up access, ideal for outdoor eating areas
- Available in multiple sizes with 1, 2, and 4-seat options
- Thermoplastic finish with powder coated frame
- Inground (S) or surface mount (SM)
- Pattern: perforated only
- See page 97 for color options

1 SEAT	2 SEAT	4 SEAT
501-P	502-P	504-P



358-VC 46" Square Capri Seating Table, green diamond pattern, green frame

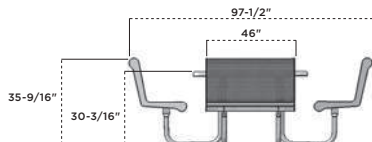

358 | CAPRI SEATING TABLE

- 46" square or octagon table top with a standard 1-9/16" dia. umbrella hole
- Thermoplastic finish with powder coated frame
- 1-5/8" O.D. all MIG welded frame with walk-through design
- All stainless steel hardware
- Portable and/or surface mount
- Seating pattern options: perforated, diamond
- See page 97 for color options

SQUARE	OCTAGON	SQUARE 3-SEAT
358-VC	358-OVC	358H-VC
358-PC	358-OPC	358H-PC



346SM-V6 6' Mall Table, inground, green diamond pattern, black frame



320-P6 6' Canopy Table, inground, ultra blue perforated pattern, black frame

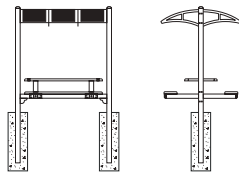

TABLE (320)

320/321 | CANOPY TABLE

- 6' lengths available with canopy
- Thermoplastic finish with powder coated frame
- 4" x 4" square all MIG welded frame and support arms
- Canopy offers protection from the sun
- All stainless steel hardware
- Inground mount only
- Pattern options: perforated, diamond
- See page 97 for color options

TABLE (320)

320-V6
320-P6

BENCH (321)

321-V6
321-P6



346SM-V6 6' Mall Table, surface mount, green diamond pattern, black frame

346 | MALL TABLE

- 6' and 8' lengths available
- Features a contemporary design with a robust build
- Thermoplastic finish with powder coated frame
- 4" x 4" x 11 ga structural steel tubing
- Inground (S) or surface mount (SM)
- Pattern options: perforated, diamond
- See page 97 for color options

6 FOOT

346-V6
346-P6

8 FOOT

346-V8
346-P8



338S-RDV 46" Round Single Pedestal Table, inground mount, red diamond pattern, black frame



338SM-RDV 46" Round Single Pedestal Table, surface mount, red diamond pattern, black frame

338 | 46" SINGLE PEDESTAL TABLE 

- 46" square, octagon, or round top table with standard 1-9/16" I.D. umbrella hole
- Thermoplastic finish with powder coated frame
- 4" x 4" square post frame with 2-7/8" O.D. round support arms
- All stainless steel hardware
- Inground (S) or surface mount (SM)
- ADA accessible option available add with inground mount only
- See page 97 for color options and 96 for patterns

SQUARE	OCTAGON	ROUND	ADA DOUBLE-SIDED	ADA SINGLE-SIDED
338-V	338-OV	338-RDV	338H2-add (H2)	338H3-add (H3)
338-P	338-OP	338-RDP		
338-VR	338-OVR			
338-PR	338-OPR			

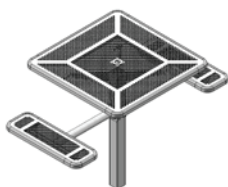

338H2

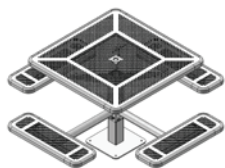

338SM-P



365 Bistro Table, Perforated, black frame, blue



360P-RDSD Round Tall Food Court Table, portable, green solid top, black frame

360/360L | PEDESTAL FOOD COURT TABLE

- 36" table top with 42" high frame or optional low (L) 30" frame
- Thermoplastic finish with powder coated frame
- 3-1/2" O.D. all MIG welded – portable (P)
- 3" Square all MIG welded – inground (S) or surface mount (SM)
- All stainless steel hardware
- Portable standard (P) and with round post, or surface mount (SM) and Inground (S) with square post
- Can be used with the 956/953 food court chairs
- Umbrella hole not available
- See page 97 for color options and 96 for patterns

42" TALL	SQUARE	ROUND	30" LOW	SQUARE	ROUND
	360-V	360-RDV		360L-V	360L-RDV
	360-P	360-RDP		360L-P	360L-RDP
	360-SD	360-RDSD		360L-SD	360L-RDSD



361L-RDV Low Round Food Court Table, portable, green diamond pattern, black frame

361 | FOOD COURT TABLE

- 36" table top with 42" high frame or optional low (L) 30" frame
- 1-9/16" diameter umbrella hole
- Thermoplastic finish with powder coated frame
- 1-5/8" O.D. all MIG welded (portable)
- All stainless steel hardware
- Portable only
- Can be used with the 956/953 food court chairs
- Pattern options: perforated, diamond
- See page 97 for color options

42" TALL	SQUARE	ROUND	30" LOW	SQUARE	ROUND
	361-V	361-RDV		361L-V	361L-RDV
	361-P	361-RDP		361L-P	361L-RDP
	361-SD	361-RDSD		361L-SD	361L-RDSD



956-V Tall Food Court Chairs, green diamond pattern, green frame



953-V Low Food Court Chairs, green diamond pattern, black frame

953/956 | TALL AND STANDARD FOOD COURT CHAIRS

- 30" tall chair with 18" wide contour seat
- Thermoplastic finish with powder coated frame
- 1-5/16" O.D. all MIG welded
- All stainless steel hardware
- Portable only
- Can be used with the 42" tall 360/361 tables
- 18" contour seat
- Thermoplastic finish with powder coated frame
- 1-5/16" O.D. all MIG welded arched support legs and arms
- All stainless steel hardware
- Portable only
- Can be used with the 30" tall 360L/361L tables
- See page 97 for color options and 96 for patterns

30" CHAIR	18" CHAIR
956-V	953-V
956-P	953-P
956-FB	953-FB
956-W	953-W
956-S	953-S

NEW 365 | BISTRO TABLE

- 46" round table top featuring swivel seats with 180° rotation
- Standard umbrella hole
- Ergonomic foot rest
- 2-3/8" O.D. all MIG welded frame
- Portable and/or surface mount
- Thermoplastic coated with powder coated frame
- Stainless steel and zinc coated hardware fasteners
- Pattern options: perforated, diamond
- See page 97 for color options

BISTRO TABLE

365-RDV
365-RDP



362 | LION BAR HEIGHT TABLE

- 46" table top with a standard 1-9/16" diameter umbrella hole
- Thermoplastic finish with powder coated frame
- 2-3/8" O.D. all MIG welded frame
- Cover plates available
- All stainless steel hardware
- Inground (S) or Surface Mount (SM)
- Pattern options: perforated, diamond
- See page 97 for color options

46" ROUND TABLE

362-RDV
362-RDP



362SM-RDV 46" Lion Bar Height Table, surface mount, ultra blue diamond pattern, ultra blue frame

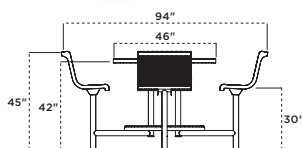

LIONCOAT & PREMIUM COLLECTION
—
RECEPTACLES





01R-41-SL Monterey Receptacle, vertical slat, black

01R-41-SL | MONTEREY RECEPTACLE

The Monterey receptacle features a side loading opening and a solid top.

- 36 gallon capacity
- Only available in powder coated finish
- 1-1/2" x 1/4" flat steel strips
- All MIG welded frame
- Portable and/or surface mount
- Lid and liner included
- See page 97 for color options



01R-AG-36FT Monterey Receptacle, vertical slat, fl at top lid, spartan bronze

01R-AG-36 | LA MARCHE RECEPTACLE

- 36 gallon capacity
- Only available in powder coated finish
- 1-1/2" x 1/4" flat steel strips
- Top and bottom rings are 1" pipe
- All MIG welded frame
- Portable and/or surface mount
- Lid and liner included
- See page 97 for color options

FLAT TOP	ASH URN	RAIN BONNET
01R-AG-36FT	01R-AG-36AU	01R-AG-36RB



01R-51-HX Huntington Receptacle, fl at top lid, spartan bronze frame with burgundy backing

01R-51-HX | MADISON RECEPTACLE

- 32 gallon capacity
- Only available in powder coated finish
- Inner shield can be powder coated in a different color
- 1" square steel tubing
- Top and bottom rings are 1-1/2" square steel tubing
- All MIG welded
- Portable and/or surface mount
- Lid and liner included
- See page 97 for color options

FLAT TOP	ASH URN	RAIN BONNET
01R-51-HXFT	01R-51-HXAU	01R-51-HXRB



01R-LX-36RB Lexington Receptacle, vertical slat, spartan bronze with matching rain bonnet lid



01R-LX-36FT La Marche Trash Receptacle, vertical slat, beige with matching fl at top lid

01R-LX-36 | LA MARCHE RECEPTACLE

- 36 gallon capacity
- Only available in powder coated finish
- 1/8" x 2" steel flat bar
- All MIG welded frame
- Portable and/or surface mount
- Lid and liner included
- See page 97 for color options

FLAT TOP	ASH URN	RAIN BONNET
01R-LX-36FT	01R-LX-36AU	01R-LX-36RB

Add a decal to most lids to give a receptacle the versatility of being both a trash receptacle and recycling receptacle.



01R-LX-72 Dual La Marche Trash Receptacle, vertical slat, black with (2) matching fl at top lids with decal option

01R-LX-72 | DUAL LA MARCHE RECEPTACLE

- Holds 2 32 gallon liners and 2 powder coated lids
- Only available in powder coated finish
- 1/8" x 2" steel flat bar
- Zinc plated hardware
- Optional decals are white lettering with black background
- Decals installed onsite
- Portable and/or surface mount
- Lids and liners included
- See page 97 for color options

FLAT TOP	ASH URN	RAIN BONNET
01R-LX-72-FT	01R-LX72-AU	01R-LX-72-RB

DECAL OPTIONS			
"CANS"	"PLASTICS"	"TRASH"	"RECYCLE"
01R-01-05-0136	01R-01-05-0137	01R-01-05-0135	01R-01-05-0130

01R-OX-36FT Carmel Receptacle, ultra blue vertical slat with fl at top lid



01R-OX-36FT Carmel Receptacle, ultra blue vertical slat with matching fl at top lid

01R-OX-36 | CARMEL RECEPTACLE

- 36 gallon capacity
- Thermoplastic finish
- Slat design with flared top
- All MIG welded
- Lid and liner included

FLAT TOP	ASH URN	RAIN BONNET
01R-OX-36FT	01R-OX-36AU	01R-OX-36RB

01R-CL-36 | FRANKLIN DOOR RECEPTACLE

- 1/4" x 1-1/2" steel flat bar
- All MIG welded frame
- Only available in powder coated finish
- All stainless steel hardware
- Portable and/or surface mount
- Lid and liner included



01R-CL-36 Franklin Door Receptacle, vertical slat, black with matching fl at top lid

FLAT TOP LID	ASH URN LID	RAIN BONNET LID
01R-CL-36FT	01R-CL-36AU	01R-CL-36RB



01R-PR-32 Metal Trash Receptacle, blue perforated pattern with RT-32 Round Top Lid and PL-32 Liner



01R-JK-36FT Jackson Receptacle, green vertical slat with matching fl at top lid

01R-JK-36 | JACKSON RECEPTACLE

- 36 gallon capacity
- Only available in powder coated finish
- 1/8" x 2" steel flat bar
- All MIG welded frame
- Portable and/or surface mount
- Lid and liner included
- See page 97 for color options

FLAT TOP	ASH URN	RAIN BONNET
01R-JK-36FT	01R-JK-36AU	01R-JK-36RB



01R-SD-36FT Franklin Door Receptacle, vertical slat, blue with matching fl at top lid

01R-SD-36FT | FRANKLIN DOOR RECEPTACLE

- 36 gallon capacity
- Thermoplastic finish
- Slat design with flared top
- All MIG welded unit
- Lid and liner included
- Featuring easy access swing door
- Portable and/or surface mount

FLAT TOP	ASH URN	RAIN BONNET
01R-SD-36FT	01R-SD-36AU	01R-SD-36RB



O1R-EX-32 Metal Trash Receptacle, blue diamond pattern with **FTR-32-08** Flat Top Lid and **PL-32** Liner

O1R-W-32 Metal Trash Receptacle, red wa-ve pattern with **RT-32** Round Dome-Top Lid and **PL-32** Liner

METAL TRASH RECEPTACLES

- Available in 32 gallon and 55 gallon capacities
- Thermoplastic finish
- All MIG welded unit
- Portable with mounting kit sold separately
- Lids and liners are sold separately
- See page 48 for lids and liners
- See page 97 for color options and 96 for patterns

32 GALLON	55 GALLON
O1R-EX-32	O1R-EX-55
O1R-PR-32	O1R-PR-55
O1R-FB-32	O1R-FB-55
O1R-W-32	O1R-W-55
O1R-S-32	O1R-S-55



O1R-PR-32RE Standard Recycled Logo Receptacle, ultra blue perforated pattern with **FTR-32-08** Flat Top Lid and **PL-32** Liner

O1R-32RE | STANDARD RECYCLE LOGO RECEPTACLE

- 32 gallon capacity
- Thermoplastic finish
- All MIG welded unit
- Portable with mounting kit sold separately
- Lid and liner sold separately
- Three recycling emblems to be visible from all angles
- See page 48 for lids and liners
- Diamond (EX) and perforated (PR) patterns only
- See page 97 for color options

32 GALLON
O1R-PR-32RE
O1R-EX-32RE



You can customize most receptacles.

See page 51 for more information.

O1R-PR-32-CL Custom Metal Trash Receptacle, perforated pattern, black with optional color backing, **RBR-32-08** Rain Bonnet Lid and **PL-32** Liner



SM KIT Surface Mounting Kit



IG KIT Inground Mounting Kit

RECEPTACLE MOUNTING KITS

All trash receptacles are portable and can be converted into either inground (IG) or surface mount (SM). Kits fit 32, 36, and 55 gallon receptacles. Sold separately

- 2-3/8" O.D. all MIG welded pipe
- Powder coated black finish

SIZE	INGROUND	SURFACE
32 GAL	IG KIT	SM KIT
36 GAL	IG KIT	SM KIT
55 GAL	IG KIT	SM KIT

RECEPTACLES

METAL RECEPTACLE LIDS

- Fits our 32 or 55 gallon receptacles
- 8" opening (08) standard
- Optional 14" opening (14) available
- 23-3/4" I.D. opening (32 gallon tops)
- 1/2" diameter rod (AUR & RBR)
- All MIG welded frame (AUR & RBR)



01R-FTR-32-08

FTR-01R | FLAT TOP

- 24" w (26³/₄" for 55 gal.)
- Spun metal lid
- Thermoplastic lids required on thermoplastic receptacles
- Powder coated lids required on recycled plastic receptacles
- See page 97 for color options

SIZE	8" OPENING	14" OPENING
32 GAL	01R-FTR-32-08	01R-FTR-32-14
55 GAL	01R-FTR-55-08	01R-FTR-55-14

01R-RT-32 | ROUND TOP



01R-RT-32

- 11³/₄" h x 24 7/8" w
- 32 gallon 24" I.D.
- Heavy duty polyethylene w/ swing door
- Only available on thermoplastic receptacles
- Comes standard as black (also available in Brown, Gray, or Blue)

32 GAL 01R-RT-32

01R-DT-32 | DOME TOP



01R-DT-32

- 17" h x 24³/₈" w for 32 gal.
- 18" h x 28¹/₄" w for 55 gal.
- 32 gal. 24" I.D. and 55 gal. 27" I.D.
- Heavy duty polyethylene w/ swing door
- Only available on thermoplastic receptacles
- Black only

32 GAL 01R-DT-32 55 GAL 01R-DT-55



01R-AUR-32-08

01R-AUR | ASH URN

- 13" h x 24" w (26³/₄" for 55 gal.)
- 20 gauge spun metal bonnet and ash urn
- Thermoplastic lids required on thermoplastic receptacles
- Powder coated lids required on recycled plastic receptacles
- See page 97 for color options

SIZE	8" OPENING	14" OPENING
32 GAL	01R-AUR-32-08	01R-AUR-32-14
55 GAL	01R-AUR-55-08	01R-AUR-55-14

01R-RBR | RAIN BONNET



01R-RBR-32-08

- 13" h x 24" w (26³/₄" for 55 gal.)
- 20 gauge spun metal bonnet
- Thermoplastic lids required on thermoplastic receptacles
- Powder coated lids required on recycled plastic receptacles
- See page 97 for color options

SIZE	8" OPENING	14" OPENING
32 GAL	01R-RBR-32-08	01R-RBR-32-14
55 GAL	01R-RBR-55-08	01R-RBR-55-14

See page 47 for receptacle mounting kits



01R-PL | RECEPTACLE LINER

- Liner fits most of our 32 and 55 gallon trash receptacles.
- 32-Gallon measures 21-7/8" wide x 27-1/2" tall
- 55-Gallon measures 23-3/8" wide x 31-3/8" tall
- Heavy-Duty Plastic
- Sold separately unless noted

32 GALLON 55 GALLON
PL-32-01R PL-55-01R



CABLE | 18" CABLE

Cable is sold separately. **Specify cable when ordering lid and receptacle**

- Attachment is used to keep the lid and trash receptacle permanently connected
- 3/32" diameter braided cable

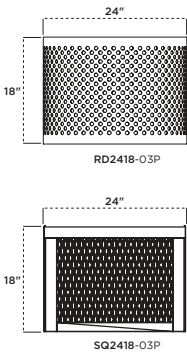

03P-RD2418/SQ2418 | PLANTER

- 24" wide x 18" high planters
- Thermoplastic finish
- All MIG welded frame
- Diamond (V) or Perforated (P) design
- Portable and/or surface mount
- 01-05-0212 liner sold separately
- See page 97 for color options

SQUARE	ROUND
03P-SQ2418-V	03P-RD2418-V
03P-SQ2418-P	03P-RD2418-P

03P-RD2418-P Round Planter, black perforated pattern



03P-RD2418-LX | LEXINGTON PLANTER

- 24" wide x 18" high planters
- Powder coated finish
- 1/8" x 2" steel flat bar
- All MIG welded frame
- Portable and/or surface mount
- Inground mounting kit available - sold separately
- 01-05-0212 liner sold separately
- See page 97 for color options

03P-RD2418-LX LaMarche Planter, brown vertical slat pattern



03P-12/12AT | ASH TRAY & ASH TRAY/TRASH COMBO

- 12 Series Ash Tray and 12AT Ash Tray/Trash combination.
- 12-1/2" wide x 24" high
- All MIG welded
- Portable and/or surface mount
- Liner included with EX-12 and PR-12 only
- See page 97 for color options

STYLE	ASH TRAY	ASH TRAY/TRASH COMBO
Diamond Pattern	03P-EX-12	03P-EX-12AT
Perforated Pattern	03P-PR-12	03P-PR-12AT

03P-PR-12AT Ash Tray/ Trash Combo, green perforated pattern

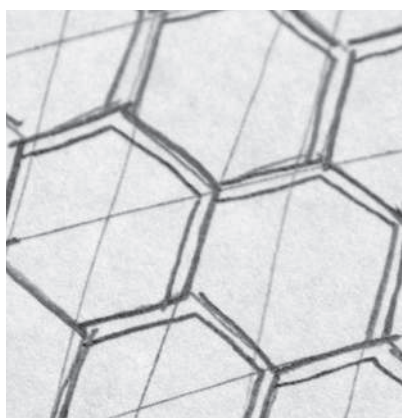
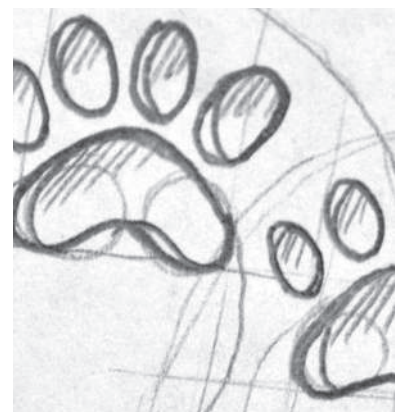
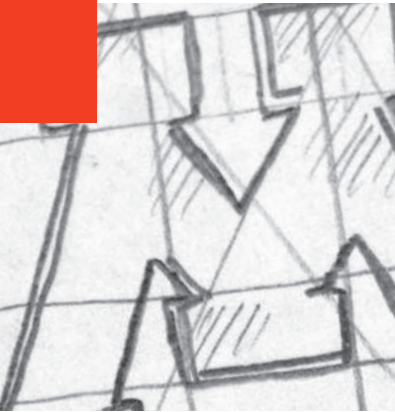

LOGOS & LETTERING

Include your logo, emblem, or insignia on most Lion Outdoor® classic furnishings.

- Smooth cut edges
- Artwork is converted to an exact replica
- Customized typeface and style
- 2D proof provided for approval

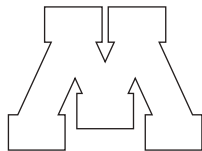
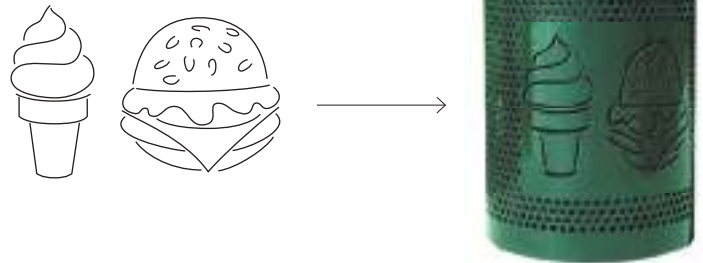

BLUFF CITY



O4C-PR-55-CL Custom Metal Trash Receptacle, black perforated pattern with optional ultra silver backing, shown with FTR-55-08 Flat Top Lid, and PL-55 Liner



BUDDY BENCH BUILDER

CREATE YOUR VERY OWN CUSTOM BUDDY BENCH FOLLOWING OUR EASY 4 STEP PROCESS.

Please give us a call if you have any questions and a customer service representative will be happy to assist you. 800-458-5872

1

CHOOSE YOUR BUDDY BENCH



02B-940P-P6-BB 6' Buddy Bench, portable, blue diamond pattern, black frame

02B-940 | BUDDY BENCH

- Available in 6' or 8'
- Diamond or Perforated Pattern
- Portable (P), inground (S), or surface mount (SM)
- Thermoplastic finish (on seat and back) with powder coated frame
- 1" O.D. Brace (portable frame only)



02B-954-CL 6' LaMarche Buddy Bench, red slat pattern

02B-954 | LA MARCHE BUDDY BENCH

- Available in 6' or 8'
- Slat pattern
- Portable and/or surface mount
- 1-1/2" thick cast aluminum frame
- Thermoplastic finish

2

CHOOSE YOUR LETTERING

*Don't see what you're looking for?
Call us for a custom quote!*

A. Buddy Bench

D. BUDDY BENCH

B. BUDDY BENCH

E. Buddy Bench

C. Buddy Bench

F. Buddy Bench

3

CHOOSE YOUR ICON



SUN



TREE



BALLOONS



FRIENDS



PAW PRINT

4

CHOOSE YOUR COLOR



ULTRA BLUE



BURGUNDY



GREEN



BEIGE



BLUE



RED



BROWN



BLACK

ULTRACOAT® THERMOPLASTIC COLORS

- Superior Adhesion
- Resistance to Cutting and Vandalism
- No Runs or Drips
- Smooth Finish Prevents Mold and Mildew
- Easily Repaired
- UV Protection
- Environmentally Friendly



ULTRA BLUE



BURGUNDY



GREEN



BEIGE



BLUE



RED



BROWN



BLACK



YELLOW



PURPLE



DARK GREY



MATTE BLACK



WHITE

STANDARD POWDER COAT COLORS

The steel framework used in the UltraCoat® product line delivers one of the industry's most durable protective coatings. Lion Outdoor® further enhances the durability by applying a superior powder coated finish. The process provides five layers of protection from harmful environmental elements, with very little maintenance.



02B-940PPS-V3 3' Portable Preschool Bench, red diamond pattern, black frame

02B-940PPS | 3' PORTABLE PRESCHOOL BENCH

- 3' length with 12" high seating
- Thermoplastic finish and powder coated frame
- 1-5/8" O.D. all MIG welded pipe
- 1" O.D. brace (portable frame only)
- All stainless steel hardware
- Portable (P) or inground (S)
- See page 97 for color options and 96 for seating patterns

PRESCHOOL

02B-940PPS-V3

02B-940PPS-P3

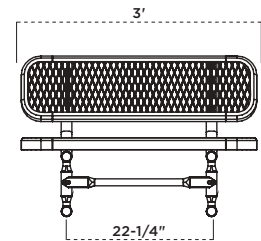
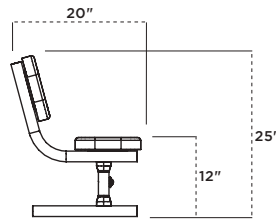

58PS-V66' Rectangular Preschool Table, green diamond pattern, black frame

02B-158PS | RECTANGULAR PRESCHOOL TABLE

- Available in 4', 6', and 8' lengths with 20" high top and 12" high seating
- Thermoplastic finish with powder coated frame
- 1-5/8" O.D. all MIG welded pipe with 1" O.D. brace
- Walk through design
- All stainless steel hardware
- Portable
- Pattern options: perforated, diamond
- See page 97 for color options

4 FOOT

158PS-V4

158PS-P4

6 FOOT

158PS-V6

158PS-P6

8 FOOT

158PS-V8

158PS-P8

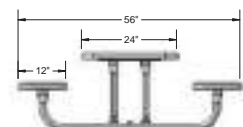



358PS-PLP Learning Table with Perforated Pattern



350PS-P Preschool Table with solid table top design and perforated seating

350PS | PORTABLE PRESCHOOL TABLE

- 46" table top and 20" high seating
- 1-5/8" O.D. all MIG welded pipe with 1" O.D. brace
- Walk through design
- All stainless steel hardware
- Also available with custom decal

46" TABLE	SQUARE	SQUARE
	Solid Top	Solid Top with Custom Decal
	350PS-P	350PS-P-DL
	350PS-V	350PS-V-DL

358PS | PORTABLE PRESCHOOL TABLE

- 46" table top and 20" high seating
- 1-5/8" O.D. all MIG welded pipe with 1" O.D. brace
- Walk through design
- All stainless steel hardware
- Also available with learning table top that includes alphabet and numbers 0-9 to compliment your early childhood setting



358PS-PLP Learning Table, perforated pattern

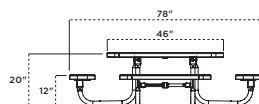

46" TABLE	SQUARE	OCTAGON	ROUND	LEARNING TABLE
	358PS-P	358PS-OP	358PS-RDP	358PS-PLP
358PS-V	358PS-OV	358PS-RDV		
358PS-VR	358PS-OVR			
358PS-PR	358PS-OPR			

NATURAL COLLECTION



100% Recycled Plastic Planks



02B-968-CDR6 6' Charleston Recycled Bench without back, cedar recycled plastic planks, black frame

02B-968 | FLORENCE RECYCLED BENCH WITHOUT BACK

- 6' and 8' lengths
- Recycled planks with thermoplastic finish on frame
- 1-1/2" thick cast aluminum frame
- All stainless steel hardware
- Portable and/or surface mount
- See page 95 for plank color options

6 FOOT	8 FOOT
02B-968-GRY6	02B-968-GRY8
02B-968-CDR6	02B-968-CDR8
02B-968-BRN6	02B-968-BRN8
02B-968-GRN6	02B-968-GRN8

See page 65 for matching receptacle.



02B-964-BRN6 6' Charleston Recycled Bench, brown recycled plastic planks, black frame

02B-964 | FLORENCE RECYCLED BENCH WITH BACK

- 6' and 8' lengths
- Recycled planks with thermoplastic finish on frame
- 1-1/2" thick cast aluminum frame
- All stainless steel hardware
- Portable and/or surface mount
- See page 95 for plank color options

6 FOOT	8 FOOT
02B-964-GRY6	02B-964-GRY8
02B-964-CDR6	02B-964-CDR8
02B-964-BRN6	02B-964-BRN8
02B-964-GRN6	02B-964-GRN8



02B-982SM-GRN46 6' Recycled Bench with Back, surface mount, 4" x 4" green recycled plastic planks, black frame

02B-982 | RECYCLED BENCH WITH BACK

- Available in 6' or 8' lengths
- Available with 2" x 4", 3" x 4", or 4" x 4" recycled plastic planks with powder coated finish or hot dip galvanized frame
- Available with wood plank options
- 3" x 3" square all MIG welded frame
- All zinc plated hardware
- Surface mount (SM) or inground mount (S)
- See page 95 for plank color options

6 FOOT	2" x 4" <input type="checkbox"/>	3" x 4" <input type="checkbox"/>	4" x 4" <input type="checkbox"/>
	02B-982-GRY6	02B-982-GRY36	02B-982-GRY46
02B-982-CDR6	02B-982-CDR36	02B-982-CDR46	
02B-982-BRN6	02B-982-BRN36	02B-982-BRN46	
02B-982-GRN6	02B-982-GRN36	02B-982-GRN46	

8 FOOT	2" x 4" <input type="checkbox"/>	3" x 4" <input type="checkbox"/>	4" x 4" <input type="checkbox"/>
	02B-982-GRY8	02B-982-GRY38	02B-982-GRY48
02B-982-CDR8	02B-982-CDR38	02B-982-CDR48	
02B-982-BRN8	02B-982-BRN38	02B-982-BRN48	
02B-982-GRN8	02B-982-GRN38	02B-982-GRN48	

BENCHES



02B-952SM-GRN46 6' Recycled Bench without Back, surface mount, 4" x 4" green recycled plastic planks, black frame

02B-952 | RECYCLED BENCH WITHOUT BACK

- Available in 6' or 8' lengths
- Available with 2" x 4", 3" x 4", or 4" x 4" recycled plastic planks with powder coated or hot-dip galvanized frame
- Available with wood plank options
- 3" x 3" square all MIG welded frame
- All zinc plated hardware
- Surface mount (SM) or inground mount (S)
- See page 97 for frame color options and 95 for plank color options

	2" x 4" <input type="checkbox"/>	3" x 4" <input type="checkbox"/>	4" x 4" <input type="checkbox"/>
6 FOOT	02B-952-GRY6	02B-952-GRY36	02B-952-GRY46
	02B-952-CDR6	02B-952-CDR36	02B-952-CDR46
	02B-952-BRN6	02B-952-BRN36	02B-952-BRN46
	02B-952-GRN6	02B-952-GRN36	02B-952-GRN46
8 FOOT	02B-952-GRY8	02B-952-GRY38	02B-952-GRY48
	02B-952-CDR8	02B-952-CDR38	02B-952-CDR48
	02B-952-BRN8	02B-952-BRN38	02B-952-BRN48
	02B-952-GRN8	02B-952-GRN38	02B-952-GRN48



02B-940P-GRN6 6' Extra Heavy Duty Bench, portable, 2"x4" green recycled plastic planks, galvanized frame

02B-940 | EXTRA HEAVY-DUTY BENCH

- Available in 6' or 8' lengths
- Standard 2" x 4" planks with the option of 2" x 10" planks with powder coated or hot-dip galvanized frame
- All MIG welded frame
- Brace is 1" O.D. pipe
- All Zinc plated hardware
- Portable (P), inground (S), or surface mount (SM)
- See page 97 for frame color options and 95 for plank color options

	2" x 4"	2" x 10"	2" x 4"	2" x 10"
6 FOOT	02B-940-U6	02B-940-U16	02B-940-U8	02B-940-U18
	02B-940-PT6	02B-940-PT16	02B-940-PT8	02B-940-PT18
	02B-940-T6	02B-940-T16	02B-940-T8	02B-940-T18
	02B-940-GRY6	02B-940-GRY16	02B-940-GRY8	02B-940-GRY18
	02B-940-CDR6	02B-940-CDR16	02B-940-CDR8	02B-940-CDR18
	02B-940-BRN6	02B-940-BRN16	02B-940-BRN8	02B-940-BRN18
8 FOOT	02B-940-GRN6	02B-940-GRN16	02B-940-GRN8	02B-940-GRN18
	02B-940-F6 (frame only)		02B-940-F8 (frame only)	



02B-965SM-BRN6 6' Double-Post Contour Park Bench, surface mount, brown recycled plastic planks, brown frame

02B-965 | DOUBLE-POST CONTOUR PARK BENCH

- Available in 6' or 8' lengths
- Standard 2" x 4" planks with 8-slat contoured seating
- All MIG welded frame made of 2-3/8" O.D. pipe
- Frame can be powder coated or hot-dip galvanized
- Zinc plated hardware
- Inground (S), surface mount (SM) or Portable (P)
- See page 97 for frame color options and 95 for plank color options

6 FOOT	8 FOOT
02B-965-U6	02B-965-U8
02B-965-PT6	02B-965-PT8
02B-965-T6	02B-965-T8
02B-965-GRY6	02B-965-GRY8
02B-965-CDR6	02B-965-CDR8
02B-965-BRN6	02B-965-BRN8
02B-965-GRN6	02B-965-GRN8



02B-975SM-PT6 6' Single-Post Contour Park Bench, surface mount, pressure treated wood planks, brown frame

02B-975 | SINGLE-POST CONTOUR PARK BENCH

- Available in 6' or 8' lengths
- Standard 2" x 4" planks with 8-slat contoured seating
- All MIG welded frame made of 2-3/8" O.D. pipe
- Frame can be powder coated or hot-dip galvanized
- Zinc plated hardware
- Inground (S) or surface mount (SM)
- See page 97 for frame color options and 95 for plank color options

6 FOOT	8 FOOT
02B-975-U6	02B-975-U8
02B-975-PT6	02B-975-PT8
02B-975-T6	02B-975-T8
02B-975-GRY6	02B-975-GRY8
02B-975-CDR6	02B-975-CDR8
02B-975-BRN6	02B-975-BRN8
02B-975-GRN6	02B-975-GRN8



02B-61S-CDR6 6' Sahara Bench with Back, cedar recycled plastic planks, black frame

02B-61 | SAHARA BENCH WITH BACK

- 6' length
- Features 3" square tubing legs
- Recycled plastic planks
- Powder coated frame finish
- Inground (S) or surface mount (SM)
- See page 95 for plank color options

6 FOOT
02B-61-GRY6
02B-61-CDR6
02B-61-BRN6
02B-61-GRN6



02B-62S-CDR6 6' Richmond Bench without Back, cedar recycled plastic planks, black frame

02B-62 | RICHMOND BENCH WITHOUT BACK

- 6' length
- Features 3" square tubing legs
- Recycled plastic planks
- Powder coated frame finish
- Inground (S) or surface mount (SM)
- See page 95 for plank color options

6 FOOT
02B-62-GRY6
02B-62-CDR6
02B-62-BRN6
02B-62-GRN6



02B-992-GRN6 6' Bench without Back, 2 planters, portable, green recycled plastic planks

02B-992 / 993 | RECYCLED PLASTIC BENCH WITH PLANTERS

- 6' Recycled frame with all zinc plated hardware
- Available with 2 (992) or 3 (993) planters
- Portable (P)
- See page 95 for plank color options
- Liners sold separately 01-05-0212

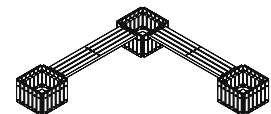

TABLES



238-GRN6 6' Extra Heavy-Duty Rectangular Table, green recycled plastic planks, portable, galvanized frame

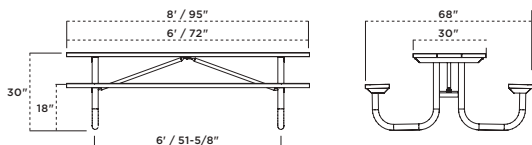

238 | EXTRA HEAVY-DUTY RECTANGULAR TABLE

- Available in 6' or 8' lengths with walk-through design
- 2" x 10" planks
- 2-3/8" O.D. all MIG welded frame with 1-5/16" O.D. brace
- Frame can be powder coated or hot-dip galvanized
- All galvanized hardware (for wood)
- All zinc plated hardware (for recycled plastic)
- Table has pre-drilled holes for a portable and/or surface mount frame
- See page 97 for frame color options and 95 for plank color options

6 FOOT	8 FOOT
238-U6	238-U8
238-PT6	238-PT8
238-T6	238-T8
238-GRY6	238-GRY8
238-CDR6	238-CDR8
238-BRN6	238-BRN8
238-GRN6	238-GRN8



238-PT6 6' Extra Heavy-Duty Rectangular Table, pressure treated planks, portable, galvanized frame

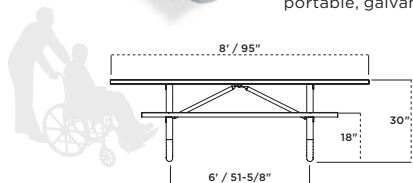

238H | ADA ACCESSIBLE TABLE 

- Available in an 8' ADA accessible option with choice of double-sided (H) or single-sided (HS) accessibility
- Recycled planks available in Double-Sided (H) only
- Frame can be powder coated or hot-dip galvanized
- All galvanized hardware (for wood)
- See page 97 for frame color options and 95 for plank color options

ADA Double-Sided	ADA Single-Sided
238H-U8	238HS-U8
238H-PT8	238HS-PT8
238H-T8	238HS-T8



238H-4-PT10 10' ADA Shelter Table, pressure treated planks, portable, brown frame

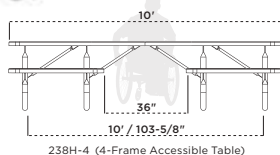

238H-4 (4-Frame Accessible Table)

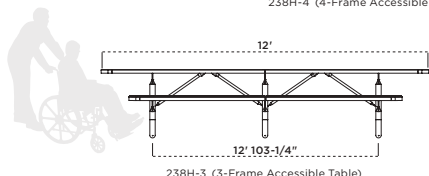

238H-3 (3-Frame Accessible Table)

238H | ADA SHELTER TABLE 

- Available in 10' and 12' lengths with walk-through design
- Available as 3 or 4 frames
- 2" x 10" planks
- 2-3/8" O.D. all MIG welded frame with 1-5/16" brace
- Frame can be powder coated or hot-dip galvanized
- All galvanized hardware (for wood)
- All zinc plated hardware (for recycled plastic)
- Portable and/or surface mount
- See page 97 for frame color options and 95 for plank color options

10' ADA 4-Frame	12' ADA 3-Frame
238H-4-U10	238H-3-U12
238H-4-PT10	238H-3-PT12
238H-4-T10	238H-3-T12
238H-4-F10 (frame only)	238H-3-F12 (frame only)



238-3-T10 10' Shelter Table, redwood stain planks, portable, galvanized frame

238-3 | SHELTER TABLE

- Available in 10' and 12' lengths with walk-through design
- 2" x 10" planks
- 2-3/8" O.D. all MIG welded frame
- 1-5/16" O.D. brace
- Frame can be powder coated or hot-dip galvanized
- All galvanized hardware (for wood)
- Portable and/or surface mount
- See page 97 for frame color options and 95 for plank color options

10 FOOT	12 FOOT
238-3-U10	238-3-U12
238-3-PT10	238-3-PT12
238-3-T10	238-3-T12
238-3-F10 (frame only)	238-3-F12 (frame only)



BT238-BRN6 6' Bolt-Thru Extra Heavy-Duty Rectangular Table, portable, brown recycled planks, galvanized frame

BT238 | BOLT-THRU EXTRA HEAVY-DUTY TABLE

- 6' and 8' lengths
- 2" x 10" planks
- 2-3/8" O.D. bolt-thru frame
- 1-5/16" O.D. brace
- Frame can be powder coated or hot-dip galvanized
- All galvanized hardware (for wood)
- All zinc plated hardware (for recycled plastic)
- Portable and/or surface mount
- See page 97 for frame color options and 95 for plank color options

6 FOOT	8 FOOT
BT238-U6	BT238-U8
BT238-PT6	BT238-PT8
BT238-T6	BT238-T8
BT238-GRY6	BT238-GRY8
BT238-CDR6	BT238-CDR8
BT238-BRN6	BT238-BRN8
BT238-GRN6	BT238-GRN8
BT238-F6 (frame only)	BT238-F8 (frame only)



158-GRY6 6' Heavy-Duty Rectangular Table, portable, grey recycled plastic planks, black frame

158 | HEAVY-DUTY RECTANGULAR TABLE

- Available in 6' or 8' lengths with walk-through design
- 2" x 10" planks
- 1-5/8" O.D. all MIG welded frame with 1-5/16" O.D. brace
- Frame can be powder coated or hot-dip galvanized
- All galvanized hardware (for wood)
- All zinc plated hardware (for recycled plastic)
- Portable and/or surface mount
- See page 97 for frame color options and 95 for plank color options

6 FOOT	8 FOOT
158-U6	158-U8
158-PT6	158-PT8
158-T6	158-T8
158-GRY6	158-GRY8
158-CDR6	158-CDR8
158-BRN6	158-BRN8
158-GRN6	158-GRN8
158-F6 (frame only)	158-F8 (frame only)

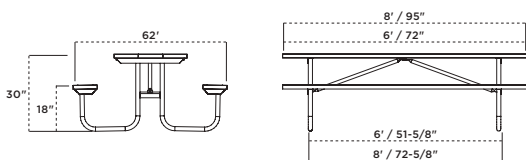

TABLES



158H-PT8 8' Double-Sided ADA Accessible Table, portable, pressure treated planks, galvanized frame

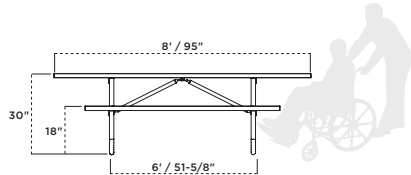

158H | ACCESSIBLE TABLE 

- Available in an 8' ADA accessible option with choice of single or double-sided accessibility
- Frame can be powder coated or hot-dip galvanized
- See page 97 for frame color options and 95 for plank color options

ADA Double-Sided	ADA Single-Sided
158H-U8	158HS-U8
158H-PT8	158HS-PT8
158H-T8	158HS-T8
158H-GRY8	
158H-CDR8	
158H-BRN8	
158H-GRN8	
158H-F8 (frame only)	158HS-F8 (frame only)



BT158-GRN6 6' Bolt-Thru Heavy-Duty Table, green recycled plastic planks, galvanized frame

BT158 | BOLT-THRU HEAVY-DUTY TABLE

- Available in 6' and 8' lengths
- 2" x 10" planks
- 1-5/8" O.D. all bolt together walk-through design
- 1-5/16" O.D. brace
- Frame can be powder coated or hot-dip galvanized
- All galvanized hardware (for wood)
- All zinc plated hardware (for recycled plastic)
- Portable and/or surface mount
- See page 97 for frame color options and 95 for plank color options

6 FOOT	8 FOOT
BT158-U6	BT158-U8
BT158-PT6	BT158-PT8
BT158-T6	BT158-T8
BT158-GRY6	BT158-GRY8
BT158-CDR6	BT158-CDR8
BT158-BRN6	BT158-BRN8
BT158-GRN6	BT158-GRN8
158-F6 (frame only)	BT158-F8 (frame only)



358-PT48 4-Seat 48" Square Table, pressure treated planks, galvanized frame

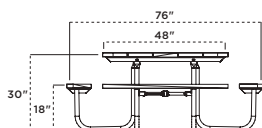

358 | 48" SQUARE TABLE

- 48" table with umbrella hole diameter 1-9/16" I.D.
- 1-5/8" O.D. all bolt together walk-through design
- 1" O.D. brace
- Frame can be powder coated or hot-dip galvanized
- All galvanized hardware (for wood)
- All zinc plated hardware (for recycled plastic)
- Portable and/or surface mount
- See page 97 for frame color options and 95 for plank color options

SQUARE TABLE
358-U48
358-PT48
358-T48
358-GRY48
358-CDR48
358-BRN48
358-GRN48



358H-CDR48 3-Seat 48" ADA Square Table, cedar recycled plastic planks, black frame

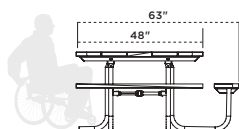

358H

358H | ADA 48" SQUARE TABLE 

- 48" table with umbrella hole diameter 1-9/16" I.D.
- ADA accessible with 3-seat
- 1-5/8" O.D. all bolt together walk-through design
- 1" O.D. brace
- Frame can be powder coated or hot-dip galvanized
- All galvanized hardware (for wood)
- All zinc plated hardware (for recycled plastic)
- Portable and/or surface mount
- See page 97 for frame color options and 95 for plank color options

ADA 3-SEAT TABLE

358H-U48
358H-PT48
358H-T48
358H-GRY48
358H-CDR48
358H-BRN48
358H-GRN48



64-CDR6 6' Sahara Table, portable, cedar recycled plastic planks, black frame

6 3 / 6 4 | SAHARA TABLE

- 6' length
- 2" x 4" recycled plastic planks
- 2-3/8" O.D. frames
- Powder coated frame
- Available as a multi pedestal table (63) or portable table with a walk-through design (64)
- Inground or surface mount (63) and portable (64)
- See page 95 for plank color options

63 SERIES	64 SERIES	64 SERIES 8	64 SERIES ADA 8 FT
63-GRY6	64-GRY6	64-GRY8	64H-GRY8
63-CDR6	64-CDR6	64-CDR8	64H-CDR8
63-BRN6	64-BRN6	64-BRN8	64H-BRN8
63-GRN6	64-GRN6	64-GRN8	64H-GRN8



349SM-GRN6 6' Multi-Pedestal Table, surface mount, green recycled plastic planks, black frame

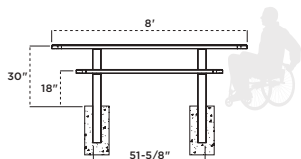

349H

349/348 | MULTI-PEDESTAL TABLE 

- Available in 6', and 8' lengths with ADA double-sided accessibility
- 2" x 10" (349) or 3" x 4" (348) recycled plastic planks
- 4" square post all MIG welded frame with walk-through design
- Powder coated frame
- All galvanized hardware (for wood)
- All zinc plated hardware (for recycled plastic)
- Inground (S) or surface mount (SM)
- See page 97 for frame color options and 95 for plank color options

SERIES 349	6 FOOT	8 FOOT	ADA 8 FOOT
	349-U6	349-U8	349H-U8
	349-PT6	349-PT8	349H-PT8
	349-T6	349-T8	349H-T8
	349-GRY6	349-GRY8	349H-GRY8
	349-CDR6	349-CDR8	349H-CDR8
	349-BRN6	349-BRN8	349H-BRN8
	349-GRN6	349-GRN8	349H-GRN8

SERIES 348	6 FOOT	8 FOOT	ADA 8 FOOT
	348-GRY6	348-GRY8	348H-GRY8
	348-CDR6	348-CDR8	348H-CDR8
	348-BRN6	348-BRN8	348H-BRN8
	348-GRN6	348-GRN8	348H-GRN8

TABLES

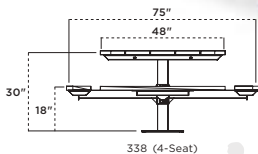

358SM-PT48 4-Seat Single Pedestal Table, pressure treated planks, black frame

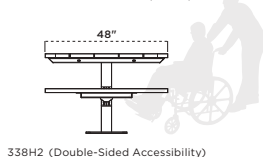

338H2 (Double-Sided Accessibility)

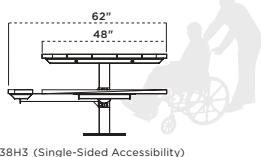

338H3 (Single-Sided Accessibility)

338/338H | 48" SINGLE PEDESTAL TABLE 

- 48" table with umbrella hole diameter 1-9/16" I.D.
- ADA accessible with 2-seat or 3-seat inground option
- 4" x 4" all MIG welded frame with 2-7/8" O.D. round support arms
- Powder coated frame
- All zinc plated hardware
- Inground (S) or surface mount (SM)
- See page 97 for frame color options and 95 for plank color options

4-SEAT	ADA 3-SEAT	ADA 2-SEAT
338-U48	338H3-U48	338H2-U48
338-PT48	338H3-PT48	338H2-PT48
338-T48	338H3-T48	338H2-T48
338-GRY48	338H3-GRY48	338H2-GRY48
338-CDR48	338H3-CDR48	338H2-CDR48
338-BRN48	338H3-BRN48	338H2-BRN48
338-GRN48	338H3-GRN48	338H2-GRN48



347-PT6 6' Dual Pedestal Rectangular Table, pressure treated planks, brown frame

347 | DUAL PEDESTAL RECTANGULAR TABLE 

- Available in 6' or 8' lengths with attached seats
- 2" x 10" planks
- Optional 8' ADA version with double-sided accessibility
- 4" x 4" all MIG welded frame
- Powder coated frame
- All zinc plated hardware (for recycled plastic)
- Inground (S) or surface mount (SM)
- See page 97 for frame color options and 95 for plank color options

6 FOOT	8 FOOT	ADA 8 FOOT
347-U6	347-U8	347H-U8
347-PT6	347-PT8	347H-PT8
347-T6	347-T8	347H-T8
347-GRY6	347-GRY8	347H-GRY8
347-CDR6	347-CDR8	347H-CDR8
347-BRN6	347-BRN8	347H-BRN8
347-GRN6	347-GRN8	347H-GRN8



337-PT6 6' Single Pedestal Rectangular Table, untreated planks, black frame

337 | SINGLE PEDESTAL RECTANGULAR TABLE 

- This table is ADA accessible and comes in 4' or 6' lengths
- 4" x 4" square main post with 3" x 3" square arm posts
- 2" x 10" planks
- Powder coated frame
- All galvanized hardware (for wood)
- All zinc plated hardware (for recycled plastic)
- Inground (S) or surface mount (SM)
- See page 97 for frame color options and 95 for plank color options

4 FOOT	6 FOOT
337-U4	337-U6
337-PT4	337-PT6
337-T4	337-T6
337-GRY4	337-GRY6
337-CDR4	337-CDR6
337-BRN4	337-BRN6
337-GRN4	337-GRN6



01R-TR-32-CDR Round Receptacle with
FT-32-08 Flat Top Lid, cedar recycled planks

01R-T-R-32 | ROUND RECEPTACLE

- 32 gallon capacity
- 34" high with a 26-11/16" diameter
- 2" x 4" planks in wood or recycled plastic
- All zinc plated hardware
- Portable with mounting kit sold separately
- Lid and liner sold separately
- See page 95 for plank color options

ROUND RECEPTACLE

01R-TR-32-U	01R-TR-32-GRY
01R-TR-32-PT	01R-TR-32-CDR
01R-TR-32-T	01R-TR-32-BRN
	01R-TR-32-GRN



01R-TRSQ-32-BRN Square Receptacle with
FT-32-TRSQ Flat Top Lid, brown recycled planks

01R-T-R-S-Q-32 | SQUARE RECEPTACLE

- 32 gallon capacity
- 34" high and 27" wide
- 2" x 4" planks in wood or recycled plastic
- All zinc plated hardware
- Portable with mounting kit sold separately
- Lid and liner sold separately
- See page 95 for plank color options

SQUARE RECEPTACLE

01R-TRSQ-32-U	01R-TRSQ-32-GRY
01R-TRSQ-32-PT	01R-TRSQ-32-CDR
01R-TRSQ-32-T	01R-TRSQ-32-BRN
	01R-TRSQ-32-GRN



01R-TRSQ-40-GRN Double Recycling
Receptacle, green recycled plastic planks

01R-T-R-S-Q-20/40/60 | RECYCLING RECEPTACLE

- Available as a single, double or triple recycling receptacle
- 2" x 4" planks in recycled plastic planks
- All zinc plated hardware
- Lid and liner sold separately
- Portable with mounting kit sold separately
- Choose between: Trash, Cans, Plastic, Paper, or Glass
- See page 95 for plank color options

SINGLE RECYCLING RECEPTACLE	DOUBLE RECYCLING RECEPTACLE	TRIPLE RECYCLING RECEPTACLE
01R-TRSQ-20-GRY	01R-TRSQ-40-GRY	01R-TRSQ-60-GRY
01R-TRSQ-20-CDR	01R-TRSQ-40-CDR	01R-TRSQ-60-CDR
01R-TRSQ-20-BRN	01R-TRSQ-40-BRN	01R-TRSQ-60-BRN
01R-TRSQ-20-GRN	01R-TRSQ-40-GRN	01R-TRSQ-60-GRN



01R-CH-GRN32FT
Florence Receptacle,
green recycled plastic
planks

01R-CH | FLORENCE RECEPTACLE

The Florence Receptacle features powder coated decorative rosettes around the top of the receptacle.

- 32 gallon capacity
- 2" x 4" recycled plastic planks
- Lid and liner are included
- Portable with mounting kit sold separately
- See page 95 for plank color options

FLAT TOP	ASH URN	RAIN BONNET
01R-CH-R32FT	01R-CH-R32AU	01R-CH-R32RB

RECEPTACLES & PLANTERS



01R-60-CDR34 Sahara Trash Receptacle, cedar recycled plastic planks

01R-60 | SAHARA TRASH RECEPTACLE

- 32 gallon capacity
- Available in recycled plastic planks
- Features metal accent tubes
- Includes liner and flat top lid
- See page 95 for plank color options

TRASH RECEPTACLE

01R-60-CDR34



03P-RD2418-BRN
Round Planter, brown recycled plastic planks



03P-SQ2418-GRN Square Planter, green recycled plastic planks

03P-RD2418/SQ2418 | PLANTER

- 18" high and 26-3/4" wide
- 2" x 4" planks in wood or recycled plastic
- All zinc plated hardware
- Portable with mounting kit sold separately
- See page 95 for plank color options
- 01-05-0212 Liner sold separately

ROUND PLANTER

03P-RD2418-U
03P-RD2418-PT
03P-RD2418-T
03P-RD2418-GRY
03P-RD2418-CDR
03P-RD2418-BRN
03P-RD2418-GRN

SQUARE PLANTER

03P-SQ2418-U
03P-SQ2418-PT
03P-SQ2418-T
03P-SQ2418-GRY
03P-SQ2418-CDR
03P-SQ2418-BRN
03P-SQ2418-GRN



01R-FT-32-TRSQ
Flat Top Lid



01R-RB-32-TRSQ
Rain Bonnet Lid



01R-AU-32-TRSQ
Ash Urn Lid

SQUARE RECEPTACLE LIDS

- Fits our 32 gallon receptacles
- 14 gauge
- All MIG welded frame (AUR & RBR)
- See page 42 for round receptacle lids
- Thermoplastic coated
- See page 97 for color options



01R-SM KIT Surface Mounting Kit



01R-IG KIT Inground Mounting Kit

RECEPTACLE MOUNTING KITS

Most trash receptacles are portable and can be converted into either inground (IG) or surface mount (SM). Kits fit 32, 36, and 55 gallon receptacles. Sold separately

- 2-3/8" O.D. all MIG welded pipe
- Powder coated black finish

SIZE **INGROUND** **SURFACE**

32 GAL 01R-IG KIT 01R-SM KIT

36 GAL 01R-IG KIT --

55 GAL 01R-IG KIT 01R-SM KIT



Customization available!

O2B-20/O21-11E | RECYCLED BENCH WITH BACK

- Available in 6' or 8' lengths
- Series 20 has six 2" x 4" recycled plastic planks
- Series 21 has four 2" x 6" recycled plastic planks
- Recycled plastic frame
- All zinc plated hardware
- Portable only
- Available in 3 plank colors: cedar, green, grey

O2B-20-CDR6 6' Recycled Bench with Back, portable, green recycled plastic planks, black frame

20 SERIES	6 FOOT	8 FOOT
	O2B-20-GRY6	O2B-20-GRY8
	O2B-20-CDR6	O2B-20-CDR8
	O2B-20-GRN6	O2B-20-GRN8

21 SERIES	6 FOOT	8 FOOT
	O2B-21-GRY6	O2B-21-GRY8
	O2B-21-CDR6	O2B-21-CDR8
	O2B-21-GRN6	O2B-21-GRN8



O2B-22 | RECYCLED BENCH WITHOUT BACK

- Available in 6' or 8' lengths
- Three 2" x 4" recycled plastic planks
- Recycled plastic frame
- All zinc plated hardware
- Portable only
- Available in 3 plank colors: cedar, green, grey

O2B-22-GRY6 6' Recycled Bench without Back, portable, grey recycled plastic planks, black frame

6 FOOT	8 FOOT
O2B-22-GRY6	O2B-22-GRY8
O2B-22-CDR6	O2B-22-CDR8
O2B-22-GRN6	O2B-22-GRN8



O2B-26 | RECYCLED PICNIC TABLES

- 6' hexagon table
- Recycled plastic planks and frame
- All zinc plated hardware
- Portable and/or surface mount
- Available in 2 plank colors: cedar or green

O2B-26-HEX-GRN 6' Hexagon Table, green recycled plastic planks, black frame

6 FOOT	ADA
O2B-26-HEX-CDR	O2B-26H-HEX-CDR
O2B-26-HEX-GRN	O2B-26H-HEX-GRN



O2B-24 | RECYCLED PICNIC TABLES

- Available in 6' or 8' lengths
- Optional 8' ADA version
- Recycled plastic planks and frame
- All zinc plated hardware
- Portable and/or surface mount
- Available in 3 plank colors: cedar, green, grey

24-CDR6 6' Rectangular Table, cedar recycled plastic planks, black frame

6 FOOT	8 FOOT	ADA 8 FOOT
24-CDR6	24-CDR8	24H-CDR8
24-GRN6	24-GRN8	24H-GRN8
24-GRY6	24-GRY8	24H-GRY8

ALUMINUM



01R-682-T Double-Sided Galvanized Trash Receptacle

01R-682 | GALVANIZED TRASH RECEPTACLE

The galvanized trash receptacles and lids can be ordered separately or with inground post and holder(s).

- 3-1/2" O.D. Post
- 1/2" Steel Bar
- 4" O.D. Adjustable Collar
- Portable (P) or inground (S)

	30 GAL CAN	30 GAL LID	HOLDER	CAN, HOLDER, CHAIN
Single-Sided	01R-G31	01R-L31	01R-681	01R-681-T
Double-Sided	—	—	01R-682	01R-682-T



02B-940-A66' Aluminum Bench, portable, galvanized frame

02B-940 | ALUMINUM BENCH

- Available in 6', 8', 15', and 21' lengths
- Standard 2" x 10" Aluminum Planks
- Frame can be powder coated or hot-dip galvanized
- Portable (P), inground (S), or surface mount (SM)

6 FOOT	8 FOOT	15 FOOT	21 FOOT
02B-940-A6	02B-940-A8	02B-940-A15	02B-940-A21



02B-942-A15 15' Aluminum Team Bench, portable, galvanized frame

02B-942 | PARK & TEAM BENCHES | WITHOUT BACK

- Available in 6', 8', 15' or 21' lengths
- 2" x 10" aluminum, wood, or recycled plastic style planks
- All MIG welded frame with zinc plated hardware
- Frame can be powder coated or hot-dip galvanized
- Brace is 1" O.D. pipe
- Portable (P), inground (S), or surface mount (SM)

6 FOOT	8 FOOT	15 FOOT	21 FOOT
02B-942-A6	02B-942-A8	02B-942-A15	02B-942-A21



238-A8 8' Extra Heavy-Duty Rectangular Table, aluminum, galvanized frame

238/238H | EXTRA HEAVY-DUTY
158/158H | RECTANGULAR TABLE

- Available in 6', 8', 10' or 12' lengths with walk-through design
- 2" x 10" planks
- 2-3/8" O.D. all MIG welded frame with 1-5/16" O.D. brace (238/238H)
- 1-5/8" O.D. all MIG welded frame with 1-5/16" O.D. brace (158/158H)
- Frame can be powder coated or hot-dip galvanized
- All zinc plated hardware
- Table has pre-drilled holes for a portable and/or surface mount frame

6 FOOT	Bolt-Thru 6 FOOT	8 FOOT	Bolt-Thru 8 FOOT	10 FOOT	12 FOOT
238-A6	BT238-A6	238-A8	BT238-A8	238-3-A10	238-4-A12
158-A6	BT-158-A6	158-A8	BT-158-A8	—	—
ADA 8 FOOT (double-sided)	ADA 8 FOOT (single-sided)	ADA 10 FOOT	ADA 12 FOOT		
238H-A8	238HS-A8	238H-3-A10	238H-3-A12		
158H-A8	158HS-A8	—	—		



02B-P257 Kid's Size Park Bench

02B-257 | KID'S SIZE PARK BENCH

- 1" O.D. all MIG welded pipe with 1" O.D. brace
- All zinc plated hardware
- Comes standard with red high density polyethylene planks and a green powder coated frame
- Seats and backs are 9" x 36"
- Portable

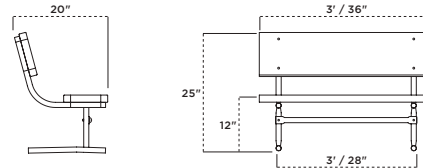

P557-PE4BL 4' Heavy-Duty Preschool Table

557 | HEAVY-DUTY 4' PRESCHOOL TABLE

- 1-5/8" O.D. all MIG welded pipe with 1" O.D. brace
- Walk through design
- All zinc plated hardware
- Available with green or blue high density polyethylene planks with powder coated frame
- Seats are 9" x 48" and table top is 30" x 48"
- Portable



G357 46" Preschool Table

357 | 46" PRESCHOOL TABLE

- 1" O.D. all bolt together frame with 1" O.D. brace
- Walk through design
- All zinc plated hardware
- Features high density polyethylene planks with zinc plated or powder coated frame
- Seats are 9" x 48" and table top is 30" x 48"
- Portable

GREEN PLANKS YELLOW FRAME	RED & GREEN PLANKS YELLOW FRAME
P357	P357-MC

GREEN PLANKS ZINC PLATED FRAME	RED & GREEN PLANKS ZINC PLATED FRAME
G357	G357-MC

ACCESSORIES





*See pages 42-45
to view Premium
receptacles*

01R-LX-36 | LAMARCHE RECEPTACLE

- 36 gallon capacity
- Only available in powder coated finish
- 1/8" x 2" steel flat bar
- All MIG welded frame
- All stainless steel hardware
- Portable and/or surface mount
- Lid and liner included

01R-LX-36FT LaMarche Trash Receptacle, vertical slat pattern, beige with matching fl at top lid



*See page 46-47
to view UltraCoat
receptacles*

METAL TRASH RECEPTACLE

- Available in 32 or 55 gallon capacities
- Thermoplastic finish
- All MIG welded unit
- Portable with mounting kit sold separately
- Lid and liner sold separately

01R-EX-32 Metal Trash Receptacle, blue diamond pattern with **FTR-32-08** Flat Top Lid and **PL-32** Liner



*See page 65 to
view Natural
receptacles*

01R-TR-32 | ROUND RECEPTACLE

- 32 gallon capacity
- 34" high with a 26-11/16" diameter
- 2" x 4" planks in wood or recycled plastic
- All zinc plated hardware
- Portable with mounting kit sold separately
- Lid and liner sold separately

01R-TR-32-CDR Round Receptacle with cedar recycled planks **FT-32-TR** Flat Top Lid



*See page 49
for additional
planters*

01R-RD2418-LX | LAMARCHE PLANTER

- 24" wide x 18" high planters
- Powder coated finish
- 1/8" x 2" steel flat bar
- All MIG welded frame
- Portable and/or surface mount
- Inground mounting kit available - sold separately

01R-RD2418-LX Lexington Planter, brown vertical slat pattern



MUV-70 7' Lion Outdoor Umbrella with wooden pole, natural



05U-MUV-70 7' Lion Outdoor Umbrella with wooden pole, pacific blue

05U-MUV | ANGLED UMBRELLA

- Wooden pole
- Acrylic Fabric
- Manual lift system
- Threaded coupling
- Vented top
- Machine washable cover
- Umbrella holder (PB16) sold separately
- See page 73 for color options

7 FOOT DIAMETER	9 FOOT DIAMETER
05U-MUV-70	05U-MUV-90



05U-758A-75 7-1/2' Lion Outdoor Umbrella with anodized aluminum pole, red

05U-758 | ROUND UMBRELLA

- Anodized aluminum pole with 3-position tilt
- (8) 3/8" diameter zinc plated steel spring wire
- Your choice of manual or crank lift
- Alternating color panels available with upcharge
- Umbrella post diameter 1-5/8" O.D.
- Umbrella holder (PB16) sold separately
- See page 73 for color options

7-1/2' GRADE A Textilene Open Weave	7-1/2' GRADE B Textilene Closed Weave
05U-758A-75	05U-758B-75



05U-7G-CRA Lion Outdoor Umbrella with bright aluminum pole, forest green



05U-7G-CRW Lion Outdoor Umbrella with white aluminum pole, pacific blue

05U-7GC | ULTRASITE® UMBRELLA

The unique fiberglass support rib construction ensures strength, resilience, and durability and holds up to the harshest weather conditions—intense sunlight, high winds, salt air, and driving rain—and will not decay or lose its shape. Our flexible fiberglass ribs absorb wind gusts without breaking and last four to five times longer than traditional steel or wood ribbed umbrellas.

- Two piece post construction
- (6) 3/8" diameter fiberglass ribs
- Each umbrella weighs 15 lbs (plus packaging)
- Molded nylon joints and end tips
- .065" thick aluminum post
- Umbrella post diameter 1-1/2" O.D.
- Anodized and powder coated finishes
- Crank lift mechanism
- Top with valance in vinyl coated weave only
- Alternating colors are not available
- Umbrella holder (PB16) sold separately
- See below for color options

White Aluminum Pole	Champagne Aluminum Pole	Bright Aluminum Pole
05U-7G-CRW	05U-7G-CRC	05U-7G-CRA

NEW UMBRELLA HOLDERS - 01-04-0484



BLACK



WHITE



BEIGE

MUV COLOR OPTIONS



758 COLOR OPTIONS OPEN WEAVE



758 COLOR OPTIONS CLOSED WEAVE

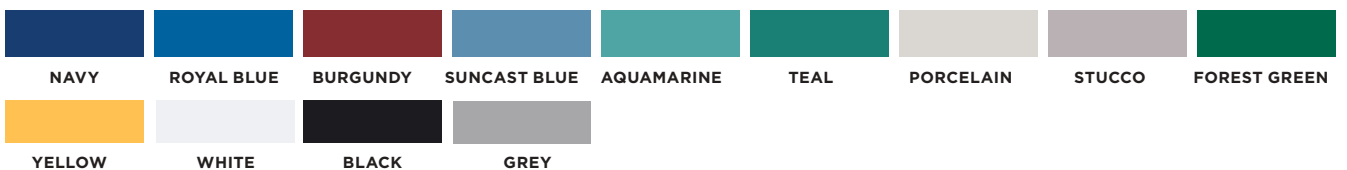

7GC COLOR OPTIONS CLOSED WEAVE





07P-5805SM Contemporary 5 Loop Bike Rack, surface mount

07P-5800 | CONTEMPORARY LOOP BIKE RACK

- 1, 3, 5, 9, 11, and 13 loop options
- 2-3/8" O.D. steel tubing
- Available as hot-dip galvanized or optional powder coated finish
- Inground (S) or surface mount (SM)
- See page 97 for color options

1 LOOP 1'3" 2 bikes	3 LOOP 2'3" 5 bikes	5 LOOP 5'3" 7 bikes	9 LOOP 9'3" 11 bikes	11 LOOPS 11'3" 13 bikes
07P-5801	07P-5803	07P-5805	07P-5809	07P-5811

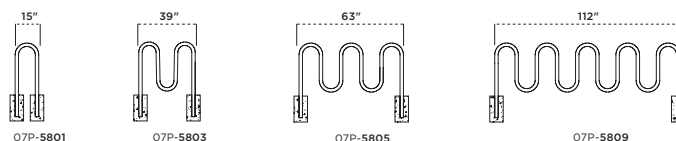

07P-5603 Hanger Rack, 3-Loop, black

07P-5603/5604/5605 | HANGER RACK

- 3, 4, and 5 loop options
- Round tubing
- Powder coated finish
- Portable (P) and/or surface mount (SM)
- See page 97 for color options

3 LOOP 6'3" 6 bikes	4 LOOP 8'3" 8 bikes	5 LOOP 10'3" 10 bikes
07P-5603	07P-5604	07P-5605

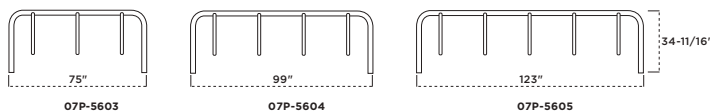

07P-5801SM 1 Loop Standard Inverted Rack

07P-5801/5801D | INVERTED SERIES

- 1, 2, 3, 4, and 5 loop options on c-channel rails
- 14.5" wide standard / 30" wide deluxe (D)
- Round tubing
- Powder coated finish
- Surface mount only
- See page 97 for color options

2 LOOP 3' 4 bikes	3 LOOP 5.5' 6 bikes	4 LOOP 8' 8 bikes	5 LOOP 10.5' 10 bikes
07P-5801-2	07P-5801-3	07P-5801-4	07P-5801-5
07P-5801D-2	07P-5801D-3	07P-5801D-4	07P-5801D-5



07P-5821D Deluxe Inverted Rack

07P-5821/5821D | INVERTED SERIES

- 1, 2, 3, 4, and 5 loop options on c-channel rails
- 18" wide standard / 30" wide deluxe (D)
- Square tubing
- Powder coated finish
- Surface mount only
- See page 97 for color options

2 LOOP 3' 4 bikes	3 LOOP 5.5' 6 bikes	4 LOOP 8' 8 bikes	5 LOOP 10.5' 10 bikes
07P-5821-2	07P-5821-3	07P-5821-4	07P-5821-5
07P-5821D-2	07P-5821D-3	07P-5821D-4	07P-5821D-5

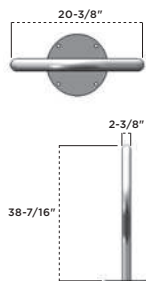

07P-5030 | FLARE RACK

- Capacity up to 2 bikes
- 38-7/16" high x 26-1/4" wide
- Framework is 2-3/8" O.D. pipe
- Powder coated finish
- Inground (S) or surface mount (SM)
- See page 97 for color options

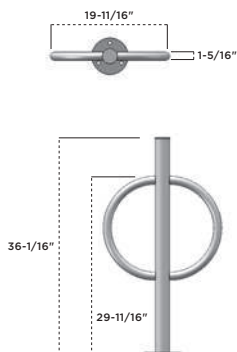

07P-5040 | HITCH RACK

- Capacity up to 2 bikes
- 36" high x 20" wide
- 2-3/8" O.D. 12 gauge steel tubing
- Rings are 1-5/16" x 14 gauge zinc tubing
- Powder coated finish
- Inground (S) or surface mount (SM)
- See page 97 for color options

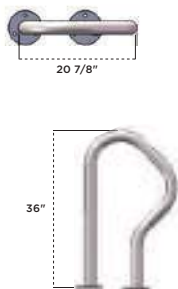

NEW 07P-5060 | FLASH BIKE RACK

- Capacity up to 2 bikes
- 38-7/16" high x 26-1/4" wide
- Framework is 2-3/8" O.D. pipe
- Powder coated finish
- Inground (S) or surface mount (SM)
- See page 97 for color options

632 Rotating Grill



07P-5020 | HORIZONS RACK

- Capacity up to 2 bikes
- Framework is 2" square x 11 gauge steel tubing
- Powder coated finish
- Inground (S) or surface mount (SM)
- See page 97 for color options

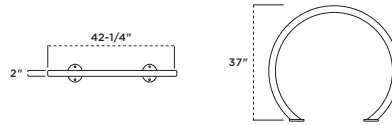

07P-500 | SOLSTICE RACK

- Capacity up to 2 bikes
- Framework is 1.9" O.D. round x 11 gauge steel tubing
- Powder coated finish
- Inground (S) or surface mount (SM)
- See page 97 for color options

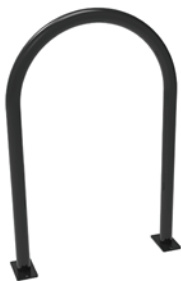
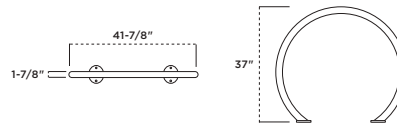

NEW 07P-5050S/5050SM | U BIKE RACK

- Capacity up to 2 bikes
- Powder coated finish
- Inground (S) or surface mount (SM)
- See page 97 for color options

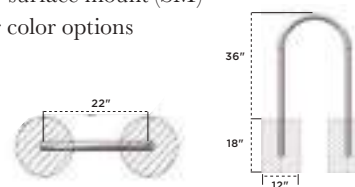



280 square inches of cooking area

08G-616 | ROTATING FLIP-BACK GRILL

- Grill measures 20"L x 14"D x 8"H
- Grill rotates a full 360°
- Durable rust-resistant high-temp black powder coated firebox
- Optional hot-dip (G) galvanized firebox and utility shelf
- 4-level adjustable cooking grate has cool-coil handles
- Grate flips back for easy clean-up and fire building
- All MIG welded 7 ga. base plate with 10 ga. side plates
- Galvanized iron pipe post inground mount
- ADA version available

	2-3/8" post	2-3/8" post with shelf	3-1/2" post	3-1/2" post with shelf
Standard	08G-616	08G-616-U	08G-616-3	08G-616-3-U
Galvanized	08G-616G	08G-616G-U	08G-616G-3	08G-616G-3-U



Lockable grill cover available (P-01-03-0135)

550 square inches of cooking area

08G-650 | DUAL GRATE GRILL

- Grill measures 20"L x 28"D x 8"H
- Durable rust-resistant high-temp black powder coated firebox
- Optional hot-dip (G) galvanized firebox and utility shelf
- 4-level adjustable cooking grate has cool-coil handles
- All MIG welded 7 ga. base plate with 10 ga. side plate
- 2-3/8" O.D. posts: permanent inground mount
- Optional lockable grill cover: P-01-03-0135 (for use when grill is out of service)



Lockable grill cover available (P-01-03-0133)

280-300 square inches of cooking area

08G-620/630 | ADJUSTABLE ROTATING GRILL

- 620 measures 20"L x 14"D x 8"H with 280 square inch cooking area
- 630 measures 20"L x 15"D x 10"H with 300 square inch cooking area
- Grill rotates a full 360°
- Durable rust-resistant, high-temp, black powder coated firebox
- Optional hot-dip (G) galvanized firebox and utility shelf
- 4-level adjustable cooking grate has cool-coil handles
- All MIG welded 7 ga. base plate with 10 ga. side plate
- 2-3/8" O.D. post (Standard on the 620) inground mount
- 3-1/2" O.D. post (Recommended on the 630) inground mount
- Optional lockable grill cover: P-01-03-0133 (for use when grill is out of service)

620 SERIES	2-3/8" post	2-3/8" post with shelf	3-1/2" post
Standard	08G-620	08G-620-U	08G-620-3
ADA Standard	08G-620H	—	08G-620H-3
Galvanized	08G-620G	08G-620G-U	08G-620G-3
ADA Galvanized	08G-620HG	—	08G-620HG-3

630 SERIES	2-3/8" post	2-3/8" post with shelf	3-1/2" post
Standard	08G-630	08G-630-U	08G-630-3
ADA Standard	—	—	08G-630H-3
Galvanized	08G-630G	08G-630G-U	08G-630G-3
ADA Galvanized	—	—	08G-630HG-3



1,008 square inches of cooking area

08G-621 | BI-LEVEL GRILL

- Grill measures 28"L x 36"D x 10"H
- Durable rust-resistant, high-temp, black powder coated firebox
- Includes a utility shelf with a 4-level adjustable cooking grate
- 4" square post with 1/4" gussets for additional support
- All MIG welded 7 ga. base plate and side walls
- Inground (S) or surface mount (SM)

GRILLS



*1,064 square inches
of cooking area*

08G-627 | COMMERCIAL GRILL

- Grill measures 28"L x 36"D x 10"H
- Durable rust-resistant, high-temp black powder coated firebox
- Cantilever cooking grate
- Grill features a double-flip-back cooking surface for easy cleaning
- 4" sq. post support tubing
- All MIG welded 7 ga. base plate with 10 ga. side walls
- Inground (S) or surface mount (SM)



*300 square inches
of cooking area*

08G-632 | ROTATING GRILL

- Grill measures 20-1/16"L x 18-5/16"D x 40"H
- Grill rotates a full 360°
- Durable rust-resistant high-temp black powder coated firebox
- Cantilever cooking grate
- All MIG welded 7 ga. base plate with 10 ga. side walls
- Inground (S) or surface mount (SM)

	3-1/2" post	3-1/2" post ADA
Standard	08G-632-3	08G-632H-3
Galvanized	08G-632G-3	08G-632HG-3



*300 square inches
of cooking area*

08G-600 | FIRE RING

- 32" diameter x 30" deep
- Durable rust-resistant, high-temp, black powder coated firebox
- Cooking grate is permanently attached with a cool-coil handle
- Grate flips back for easy clean-up and fire building
- All MIG welded 7 gauge outer wall with 1" safety lip
- Staple anchors are included for a permanent inground mount
- Fire ring only; ADA accessible double fire ring available

	7" HIGH	9" HIGH	18" HIGH ADA	18" HIGH ADA
With Grate	08G-600	08G-600-9	08G-600H	08G-600H-D (with inner ring)
No Grate	08G-601	08G-601-9	—	—



*285 square inches
of cooking area*

08G-612 | MULTI-FUNCTIONAL FIRE RING

- 32" diameter x 30" deep
- Durable rust-resistant, high-temp, black powder-coat firebox
- Permanently mounted 4-level adjustable cooking grate with cool-coil handles
- All MIG welded 7 gauge outer wall with 1" safety lip
- Staple anchors are included for a permanent inground mount

7" HIGH	9" HIGH	18" HIGH ADA	18" HIGH ADA
08G-612	08G-612-9	08G-612H	08G-612H-D (with inner ring)

**Call us for the full list of grills we have available.*

SHOWCASE



DOG PARK

09D-PBARK-410 Dog Walk & PBARK-420 Paws/Grooming Table

DOGPARK offers dog park equipment based on popular agility obstacles and has been developed for use by dogs of all abilities and confidence levels.

Most of all, DOGPARK'S are attractive and fun places for pets and their families to exercise, socialize, and enjoy nature!



09D-TBARK-430- Hoop Jump



09D-PBARK-471 Stepping Paws



DOGPARK's proprietary DogCoat™ provides slip-resistant traction, UV protection, and resistance to vandalism and urine.

DOG PARK

AGILITY OBSTACLES

DOG PARK agility obstacles are developed for use by dogs of all abilities and confidence levels.



09D-TBARK-45 ORever Jump Over



09D-PBARK Stepping Stones



09D-PBARK-491 Doggie Crawl

COORDINATING SITE AMENITIES

Featuring laser cut paw prints and bones to coordinate with your DOGPARK equipment.



09D-PBARK-940P-P6 Sit & Stay Bench



09D-TBARK-PR-32 Tidy Up Trash Receptacle shown with FTR-32-08 Flat Top Lid and PL-32 Liner, sold separately



09D-BARK-NVKIT Novice Course (includes Doggie Crawl, Hoop Jump, Paws/Grooming Table, and Rover Jump Over)

PRE-CONFIGURED AGILITY COURSES

Save time and money when you purchase one of our expertly configured courses!

TONS OF WASTE OPTIONS!



09D-PBARK-490 Pet Waste Station 09D-PBARK-488 Pet Waste Station without Receptacle



TBARK-465-09D Fire Hydrant

ACCESSORIES

From Fire Hydrants to Waste Stations, BarkPark has all of your finishing touches!



LIONSHADE

California Outdoor offers LionShade, a wide variety of high-quality engineered shade products that protect from many of Mother Nature's elements. An Lion Outdoor sales representative will guide you through a simplified design and order process to provide a shade structure that helps protect your recreation investment and your community.



LION SHELTER

California Outdoor offers LIONSHELTER, a spectrum of shelter designs that create community spaces while helping protect patrons from many of nature's elements. An Lion Outdoor® sales representative will guide you through a simplified process of providing a unique shelter that protects your recreation investment and your community.



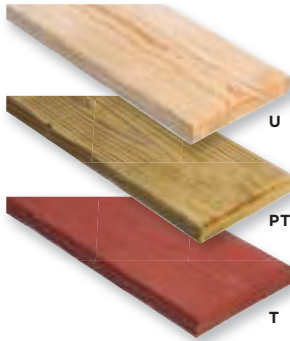

WOOD PLANKS

- 2" x 10" and 2" x 4" sizes
- Rounded edges
- #1 southern yellow pine

(U) UNTREATED

(PT) PRESSURE TREATED

- Environmentally friendly (ACQ)
- Kiln dried before and after treatment

(T) REDWOOD STAIN

- Sealed in redwood stain with wood preservative



ALUMINUM PLANKS

- 2" x 10" size
- 6063-T6 extruded aluminum alloy

(A) ANODIZED

- Used for table tops, seats, and backs on most products

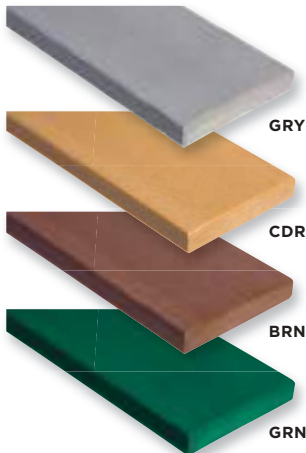

RECYCLED PLANKS

- 2" x 10", 2" x 4", 3" x 4", and 4" x 4" sizes
- Rounded edges
- 100% recycled plastic with color
- Ask about custom color options

(GRY) GRAY

(CDR) CEDAR

(BRN) BROWN

(GRN) GREEN

DIE FORMED SEAT PATTERNS

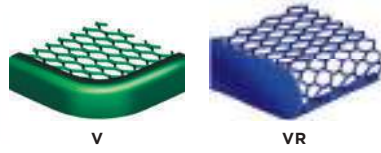

V | DIAMOND

- 9-gauge material
- Expanded metal
- Round corners
- 3/4" opening

VR | DIAMOND ROLLED EDGE

- 9-gauge material
- Expanded metal
- Rolled edge
- 3/4" opening



P | PERFORATED

- Perforated metal
- Round corners
- 5/8" diameter punched pattern
- 12-gauge sheet steel

PR | PERFORATED ROLLED EDGE

- Perforated metal
- Rolled corners
- 5/8" diameter punched pattern
- 14-gauge sheet steel



W | WAVE

- 12-gauge sheet steel



FB | FIESTA

- 12-gauge sheet steel



S | SLAT

- 12-gauge sheet steel



LIONCOAT
THERMOPLASTIC COLORS

- Superior Adhesion
- Resistance to Cutting and Vandalism
- No Runs or Drips
- Smooth Finish Prevents Mold and Mildew
- Easily Repaired
- UV Protection
- Environmentally Friendly



STANDARD
POWDER COAT COLORS

The steel framework used in the LionCoat product line delivers one of the industry's most durable protective coatings. Lion California further enhances the durability by applying a superior powder coated finish. The process provides five layers of protection from harmful environmental elements, with very little maintenance.



PREMIUM
POWDER COAT COLORS

- Additional upcharge

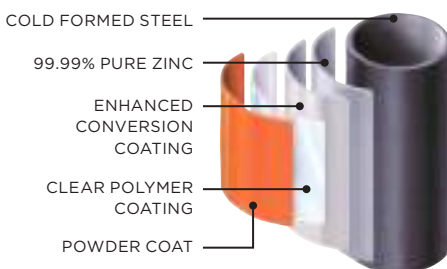

STANDARD
POWDER COAT

- Uniform coating
- Durability
- High-quality
- Attractive finish



HOT-DIP GALVANIZED

- Galvanized both inside and out
- Superior four-layer adhesion bond
- Excellent abrasion resistance
- Provides cathodic protection to the underlying steel
- Increases the useful life of steel



S I T E F U R N I S H I N G S | D O G P A R K S | S H A D E | S H E L T E R | O U T D O O R
CALIFORNIA OUTDOOR

916-719-5333 | kendrick@californiaoutdoor.co
www.californiaoutdoor.co